

JVC

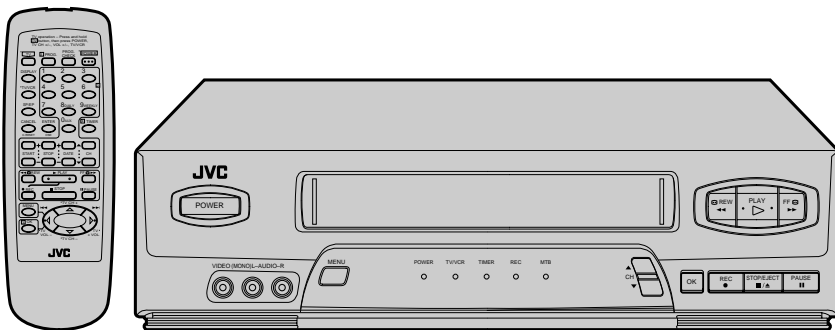

VIDEO CASSETTE RECORDER

HR-A54U (Hi-Fi) HR-A34U (Monaural)



VHS
Hi-Fi
SQP/B
VCR plus+
Easy Taping.

The VCR illustrations appearing in this instruction manual are of the HR-A54U.

INSTRUCTIONS

For Customer Use:

Enter below the Model No. and Serial No. which are located on the rear of cabinet. Retain this information for future reference.

Model No. _____

Serial No. _____

Dear Customer,

Thank you for purchasing the JVC VHS video cassette recorder. Before use, please read the safety information and precautions contained in the following pages to ensure safe use of your new VCR.

CAUTIONS

	CAUTION RISK OF ELECTRIC SHOCK DO NOT OPEN	
CAUTION: TO REDUCE THE RISK OF ELECTRIC SHOCK. DO NOT REMOVE COVER (OR BACK). NO USER-SERVICEABLE PARTS INSIDE. REFER SERVICING TO QUALIFIED SERVICE PERSONNEL.		



The lightning flash with arrowhead symbol, within an equilateral triangle, is intended to alert the user to the presence of uninsulated "dangerous voltage" within the product's enclosure that may be of sufficient magnitude to constitute a risk of electric shock to persons.



The exclamation point within an equilateral triangle is intended to alert the user to the presence of important operating and maintenance (servicing) instructions in the literature accompanying the appliance.

WARNING:
TO PREVENT FIRE OR SHOCK HAZARD, DO NOT EXPOSE THIS UNIT TO RAIN OR MOISTURE.

CAUTION:

This video cassette recorder should be used with AC 120V~, 60Hz only.
To prevent electric shocks and fire hazards, DO NOT use any other power source.

CAUTION:

TO PREVENT ELECTRIC SHOCK, MATCH WIDE BLADE OF PLUG TO WIDE SLOT, FULLY INSERT.

ATTENTION:

POUR ÉVITER LES CHOCS ÉLECTRIQUES, INTRODUIRE LA LAME LA PLUS LARGE DE LA FICHE DANS LA BORNE CORRESPONDANTE DE LA PRISE ET POUSSER JUSQU'AU FOND.

Note to CATV system installer:

This reminder is provided to call the CATV system installer's attention to Article 820-40 of the NEC that provides guidelines for proper grounding and, in particular, specifies that the cable ground shall be connected to the grounding system of the building, as close to the point of cable entry as practical.

CAUTION:

Changes or modifications not approved by JVC could void user's authority to operate the equipment.

Failure to heed the following precautions may result in damage to the VCR, remote control or video cassette.

1. DO NOT place the VCR . . .

- ... in an environment prone to extreme temperatures or humidity.
- ... in direct sunlight.
- ... in a dusty environment.
- ... in an environment where strong magnetic fields are generated.
- ... on a surface that is unstable or subject to vibration.

2. DO NOT block the VCR's ventilation openings.**3. DO NOT place heavy objects on the VCR or remote control.****4. DO NOT place anything which might spill on top of the VCR or remote control.****5. AVOID violent shocks to the VCR during transport.******MOISTURE CONDENSATION**

Moisture in the air will condense on the VCR when you move it from a cold place to a warm place, or under extremely humid conditions—just as water droplets form on the surface of a glass filled with cold liquid. Moisture condensation on the head drum will cause damage to the tape. In conditions where condensation may occur, keep the VCR's power turned on for a few hours to let the moisture dry before inserting a tape.

****ABOUT HEAD CLEANING**

Accumulation of dirt and other particles on the video heads may cause the playback picture to become blurred or interrupted. Be sure to contact your nearest JVC dealer if such troubles occur.

VCR Plus+ and PlusCode are trademarks of Gemstar Development Corporation.

The VCR Plus+ system is manufactured under license from Gemstar Development Corporation.



- Cassettes marked "VHS" (or "S-VHS") can be used with this video cassette recorder. However, S-VHS recording is not possible with this model.
- This model is equipped with SGPB (S-VHS QUASI PLAYBACK) that makes it possible to play back S-VHS recordings with regular VHS resolution.
- HQ VHS is compatible with existing VHS equipment.
- As an ENERGY STAR® Partner, JVC has determined that this product or product model meets the ENERGY STAR® guidelines for energy efficiency.

IMPORTANT PRODUCT SAFETY INSTRUCTIONS

Electrical energy can perform many useful functions. But improper use can result in potential electrical shock or fire hazards. This product has been engineered and manufactured to assure your personal safety. In order not to defeat the built-in safeguards, observe the following basic rules for its installation, use and servicing.

ATTENTION:

Follow and obey all warnings and instructions marked on your product and its operating instructions. For your safety, please read all the safety and operating instructions before you operate this product and keep this booklet for future reference.

INSTALLATION

1. Grounding or Polarization

(A) Your product may be equipped with a polarized alternating-current line plug (a plug having one blade wider than the other). This plug will fit into the power outlet only one way. This is a safety feature.

If you are unable to insert the plug fully into the outlet, try reversing the plug. If the plug should still fail to fit, contact your electrician to replace your obsolete outlet. Do not defeat the safety purpose of the polarized plug.

(B) Your product may be equipped with a 3-wire grounding-type plug, a plug having a third (grounding) pin. This plug will only fit into a grounding-type power outlet. This is a safety feature.

If you are unable to insert the plug into the outlet, contact your electrician to replace your obsolete outlet. Do not defeat the safety purpose of the grounding-type plug.

2. Power Sources

Operate your product only from the type of power source indicated on the marking label. If you are not sure of the type of power supply to your home, consult your product dealer or local power company. If your product is intended to operate from battery power, or other sources, refer to the operating instructions.

3. Overloading

Do not overload wall outlets, extension cords, or integral convenience receptacles as this can result in a risk of fire or electric shock.

4. Power Cord Protection

Power supply cords should be routed so that they are not likely to be walked on or pinched by items placed upon or against them, paying particular attention to cords at plugs, convenience receptacles, and the point where they exit from the product.

5. Ventilation

Slots and openings in the cabinet are provided for ventilation. To ensure reliable operation of the product and to protect it from overheating, these openings must not be blocked or covered.

- Do not block the openings by placing the product on a bed, sofa, rug or other similar surface.
- Do not place the product in a built-in installation such as a bookcase or rack unless proper ventilation is provided or the manufacturer's instructions have been adhered to.

6. Wall or Ceiling Mounting

The product should be mounted to a wall or ceiling only as recommended by the manufacturer.

ANTENNA INSTALLATION INSTRUCTIONS

1. Outdoor Antenna Grounding

If an outside antenna or cable system is connected to the product, be sure the antenna or cable system is grounded so as to provide some protection against voltage surges and built-up static charges. Article 810 of the National Electrical Code, ANSI/NFPA 70, provides information with regard to proper grounding of the mast and supporting structure, grounding of the lead-in wire to an antenna discharge unit, size of grounding connectors, location of antenna discharge unit, connection to grounding electrodes, and requirements for the grounding electrode.

2. Lightning

For added protection for this product during a lightning storm, or when it is left unattended and unused for long periods of time, unplug it from the wall outlet and disconnect the antenna or cable system. This will prevent damage to the product due to lightning and power-line surges.

3. Power Lines

An outside antenna system should not be located in the vicinity of overhead power lines or other electric light or power circuits, or where it can fall into such power lines or circuits. When installing an outside antenna system, extreme care should be taken to keep from touching such power lines or circuits as contact with them might be fatal.

EXAMPLE OF ANTENNA GROUNDING AS PER NATIONAL ELECTRICAL CODE, ANSI/NFPA 70

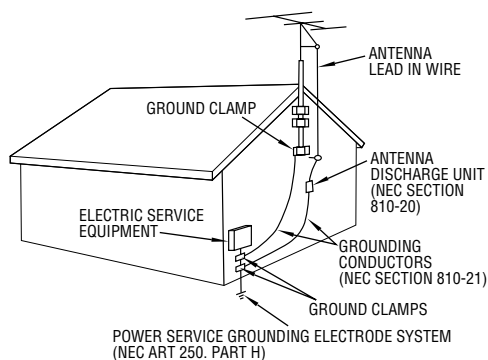

NEC – NATIONAL ELECTRICAL CODE

USE

1. Accessories

To avoid personal injury:

- Do not place this product on an unstable cart, stand, tripod, bracket, or table. It may fall, causing serious injury to a child or adult, and serious damage to the product.
- Use only with a cart, stand, tripod, bracket, or table recommended by the manufacturer or sold with the product.
- Use a mounting accessory recommended by the manufacturer and follow the manufacturer's instructions for any mounting of the product.
- Do not try to roll a cart with small casters across thresholds or deep-pile carpets.

2. Product and Cart Combination

A product and cart combination should be moved with care. Quick stops, excessive force, and uneven surfaces may cause the product and cart combination to overturn.

PORTABLE CART WARNING
(Symbol provided by RETAC)



3. Water and Moisture

Do not use this product near water—for example, near a bath tub, wash bowl, kitchen sink or laundry tub, in a wet basement, or near a swimming pool and the like.

4. Object and Liquid Entry

Never push objects of any kind into this product through openings as they may touch dangerous voltage points or short-out parts that could result in a fire or electric shock. Never spill liquid of any kind on the product.

5. Attachments

Do not use attachments not recommended by the manufacturer of this product as they may cause hazards.

6. Cleaning

Unplug this product from the wall outlet before cleaning. Do not use liquid cleaners or aerosol cleaners. Use a damp cloth for cleaning.

7. Heat

The product should be situated away from heat sources such as radiators, heat registers, stoves, or other products (including amplifiers) that produce heat.

SERVICING

1. Servicing

If your product is not operating correctly or exhibits a marked change in performance and you are unable to restore normal operation by following the detailed procedure in its operating instructions, do not attempt to service it yourself as opening or removing covers may expose you to dangerous voltage or other hazards. Refer all servicing to qualified service personnel.

2. Damage Requiring Service

Unplug this product from the wall outlet and refer servicing to qualified service personnel under the following conditions:

- a. When the power supply cord or plug is damaged.
- b. If liquid has been spilled, or objects have fallen into the product.
- c. If the product has been exposed to rain or water.
- d. If the product does not operate normally by following the operating instructions. Adjust only those controls that are covered by the operating instructions as an improper adjustment of other controls may result in damage and will often require extensive work by a qualified technician to restore the product to its normal operation.
- e. If the product has been dropped or damaged in any way.
- f. When the product exhibits a distinct change in performance—this indicates a need for service.

3. Replacement Parts

When replacement parts are required, be sure the service technician has used replacement parts specified by the manufacturer or have the same characteristics as the original part. Unauthorized substitutions may result in fire, electric shock or other hazards.

4. Safety Check

Upon completion of any service or repairs to this product, ask the service technician to perform safety checks to determine that the product is in safe operating condition.

HOW TO USE THIS INSTRUCTION MANUAL

- All major sections and subsections are listed in the Table Of Contents on page 5. Use this when searching for information on a specific procedure or feature.
- The Index on pages 38–40 lists frequently-used terms, and the number of the page on which they are used or explained in the manual. This section also illustrates the controls and connections on the front and rear panel, the front display panel and the remote control.
- The  mark signals a reference to another page for instructions or related information.
- Operation buttons necessary for the various procedures are clearly indicated through the use of illustrations at the beginning of each major section.

BEFORE YOU INSTALL YOUR NEW VCR . . .

. . . please read the sections/literature listed below.

- "Cautions" on page 2
- "Important Products Safety Instructions" on the previous pages

I **NSTALLING YOUR NEW VCR** **6**

Basic Connections 6

I **NITIAL SETTINGS** **8**

Language 8

Clock 9

Tuner 10

 Set Receivable Channels 10

 Add Or Delete A Channel 11

S **IMPLE PLAYBACK AND RECORDING** **12**

Simple Playback 12

Simple Recording 13

P **LAYBACK AND RECORDING FEATURES** **14**

Playback Features 14

 Still Picture/Frame-By-Frame Playback 14

 Slow Motion 14

 High-Speed Search 14

 Index Search 14

 Manual Tracking 15

 Video Stabilizer 16

 Repeat Playback 17

 Counter Reset 17

 Tape Position Indicator 17

 Next-Function Memory 17

 Superimpose 18

 Select The Soundtrack (HR-A54U only) 19

Auto Picture 20

 Preparation 20

 Playback 21

Recording Features 22

 Record One Program While

 Watching Another 22

 Display Elapsed Recording Time 22

 Stereo And SAP (Second Audio Program)

 (HR-A54U only) 23

 To Record SAP Programs (HR-A54U only) 23

T **IMER RECORDING** **24**

VCR Plus+ Timer Programming (HR-A54U only) 24

VCR Plus+ Setup (HR-A54U only) 26

Express Timer Programming 28

 Check, Cancel And Revise Programs 30

 Auto SP→EP Timer 31

 Auto Timer 31

Instant Timer Recording (ITR) 32

E **DITING** **33**

Edit To Another VCR 33

Edit From A Camcorder Or Another VCR 34

T **ROUBLESHOOTING** **35**

Power 35

Tape Transport 35

Playback 35

Recording 35

Timer Recording 36

Other Problems 36

Q **UESTIONS AND ANSWERS** **37**

Playback 37

Recording 37

Timer Recording 37

I **NDEX** **38**

List Of Terms 38

Front View 39

Front Panel Indicators 39

Rear View 39

Remote Control 40

S **PECIFICATIONS** **41**

F **OR SERVICING (Only in U.S.A.)** **42**

W **ARRANTY (Only in U.S.A.)** **43**

Basic Connections

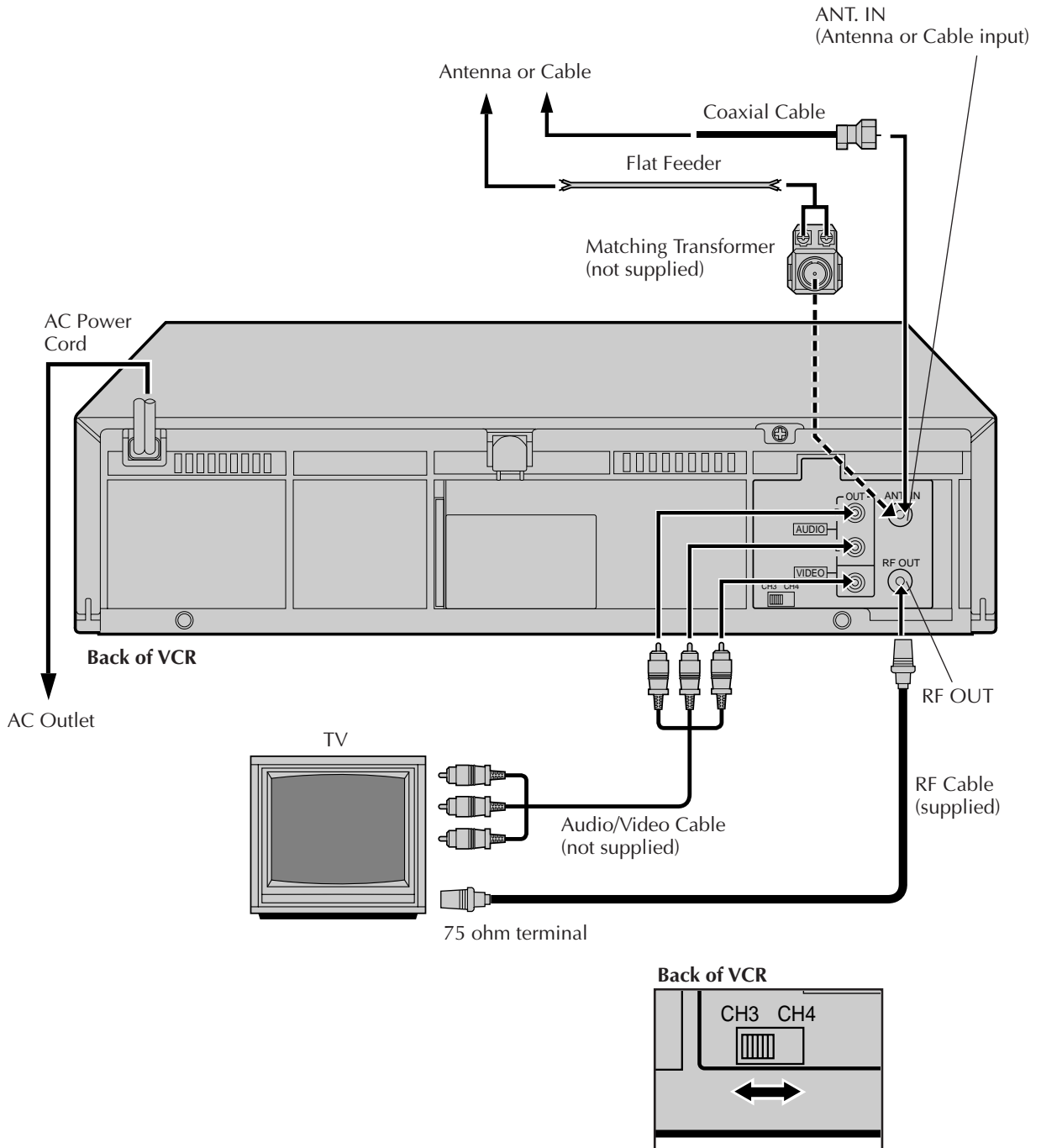

CHECK CONTENTS

1 Make sure the package contains all of the accessories listed in "SPECIFICATIONS" (☞ pg. 41).

SITUATE VCR

2 Place the VCR on a stable, horizontal surface.

CONNECT VCR TO TV

3 The connection method you use depends on the type of TV you have.

RF Connection

- *To Connect To A TV With NO AV Input Terminals . . .*
 - a- Disconnect the TV antenna from the TV.
 - b- Connect the TV antenna cable to the ANT. IN jack on the rear of the VCR.
 - c- Connect the supplied RF cable between the RF OUT jack on the rear of the VCR and the TV's antenna terminal. Set TV on CH3 or CH4 corresponding to the CH3 – CH4 switch setting on the back of the VCR.

AV Connection

- *To Connect To A TV With AV Input Terminals . . .*
 - a- Connect the antenna, VCR and TV as shown in the illustration.
 - b- Connect an Audio/Video Cable between the AUDIO OUT and VIDEO OUT jacks on the rear of the VCR and the AV IN jacks on the TV. Set your TV in video input mode or A/V input mode. Refer to the TV Instruction Manual.

For HR-A34U Owners:

If your TV has AUDIO IN L and R connectors, connect the VCR to the L connector.

CONNECT VCR TO POWER SOURCE

4 Connect the power plug to an AC outlet.

FINAL PREPARATION FOR USE

5 Power on the VCR and select the VCR channel (3 or 4) by setting the switch on the rear of the VCR as shown in the illustration.

You can now perform simple playback (☞ pg. 12) or simple recording (☞ pg. 13).

NOTES:

- *The VCR channel is the channel on the TV which will display the audio and video signals from the VCR. The VCR's CH3-CH4 switch, on the back of the VCR, sets the VCR channel to CH3 or CH4.*
- *The CH3-CH4 switch is preset to the CH3 position. Set to CH4 if CH3 is used for broadcasting in your area and set the channel on the TV to correspond to the VCR's CH3-CH4 switch setting.*
- *If RF connection to TV is used, when switching from VCR to TV mode and from TV to VCR it may be necessary to issue a CH UP and then CH DOWN on TV to obtain a good quality picture.*
- *Even if you are using AV cables to connect your VCR to your TV, you must also connect it using the RF cable. This will ensure that you can record one show while watching another (☞ pg. 22).*
- *For full identification of the VCR's rear panel, refer to the Index (REAR VIEW ☞ pg. 39).*

Language

Turn on the TV and select the VCR channel 3 or 4 (or AV mode).

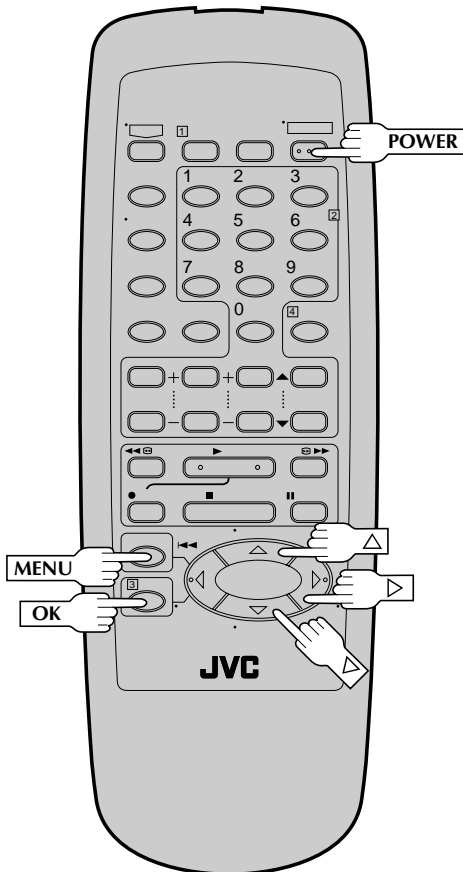
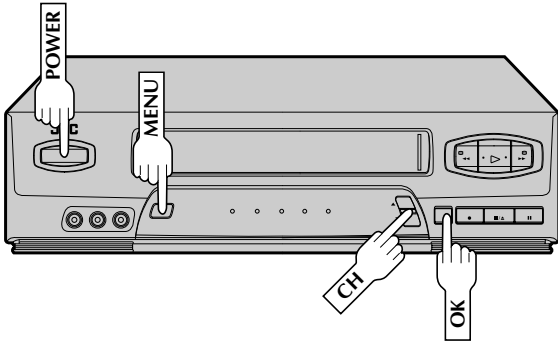

This VCR offers you the choice to view on-screen messages in English, Spanish or French (not including messages superimposed on the TV picture). Select the desired language using this procedure. The default setting is "ENGLISH".

1 TURN ON THE VCR

Press **POWER**.

2 ACCESS MAIN MENU SCREEN

Press **MENU**.

3 ACCESS INITIAL SET SCREEN

At the Main Menu screen, move the highlight bar (arrow) to "INITIAL SET" by pressing **CH▲▼** or **▲▼**, then press **OK** or **▶**.

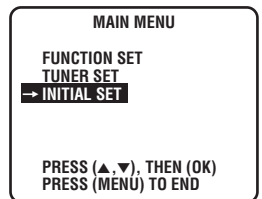

4 SELECT LANGUAGE

Move the highlight bar (arrow) to "LANGUAGE" by pressing **CH▲▼** or **▲▼**, then press **OK** or **▶** to select the desired language.

- "GUIDE CHANNEL SET" will appear with HR-A54U only.

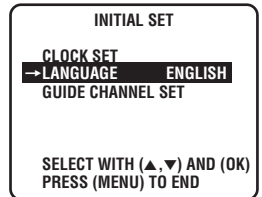

5 RETURN TO NORMAL SCREEN

Press **MENU**.

Clock

Turn on the TV and select the VCR channel 3 or 4 (or AV mode).

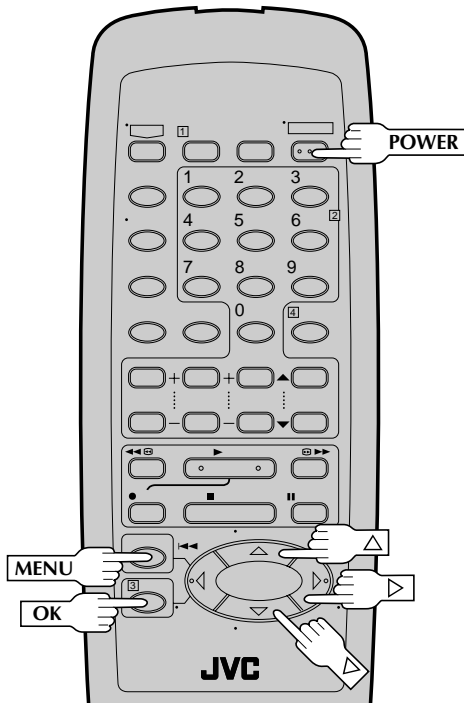
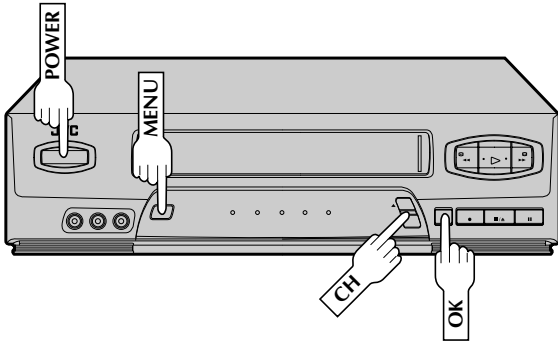

**AUTO DAYLIGHT SAVING TIME

This function enables automatic adjustment of the VCR's clock at the start and end of Daylight Saving Time.

With Auto DST activated, . . .

. . . on the first Sunday of April at 2:00 AM, the clock is adjusted to 3:00 AM.

. . . on the last Sunday of October at 2:00 AM, the clock is adjusted to 1:00 AM.

1 TURN ON THE VCR

Press **POWER**.

2 ACCESS MAIN MENU SCREEN

Press **MENU**.

3 ACCESS INITIAL SET SCREEN

At the Main Menu screen, move the highlight bar (arrow) to "INITIAL SET" by pressing **CH▲▼** or **△▽**, then press **OK** or **▷**.

4 ACCESS CLOCK SET SCREEN

Move the highlight bar (arrow) at the Initial Set screen to "CLOCK SET" by pressing **CH▲▼** or **△▽**, then press **OK** or **▷**.

- "GUIDE CHANNEL SET" will appear with HR-A54U only.

5 SET TIME

Press **CH▲▼** or **△▽** until the desired time appears, then press **OK** or **▷**.

- Press and hold **CH▲▼** or **△▽** to change the time by 30 minutes.

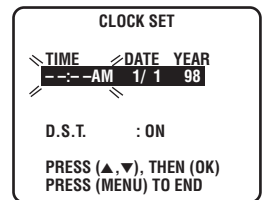

6 SET DATE

Press **CH▲▼** or **△▽** until the desired date appears, then press **OK** or **▷**.

- Press and hold **CH▲▼** or **△▽** to change the date by 15 days.

7 SET YEAR

Press **CH▲▼** or **△▽** until the desired year appears, then press **OK** or **▷** twice.

8 SELECT D.S.T. MODE

Press **CH▲▼** or **△▽** to select the desired mode.

- Set to "ON" so that the adjustment to your VCR's clock will be made on the clock itself.
- Set to "OFF" if Daylight Saving Time does not apply to you.

9 START CLOCK

Press **MENU** and normal screen appears.

To Make Corrections

Press **OK** or **▷** until the item you want to change blinks, then press **CH▲▼** or **△▽**.

Tuner

Turn on the TV and select the VCR channel 3 or 4 (or AV mode).

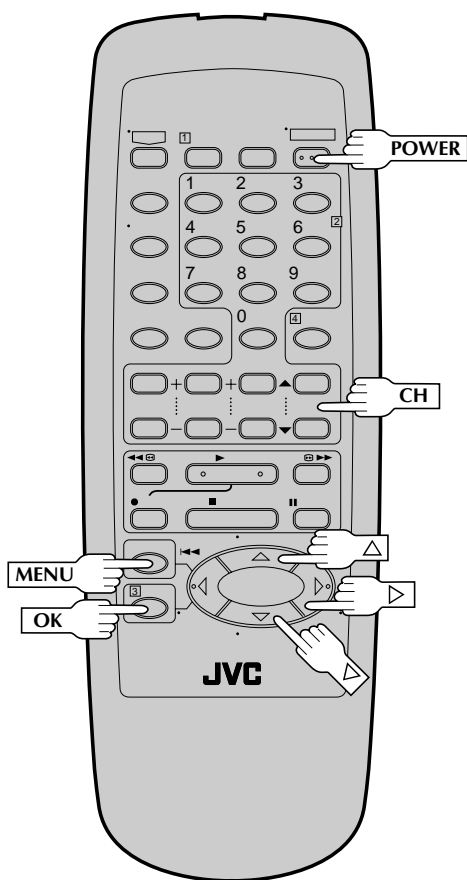
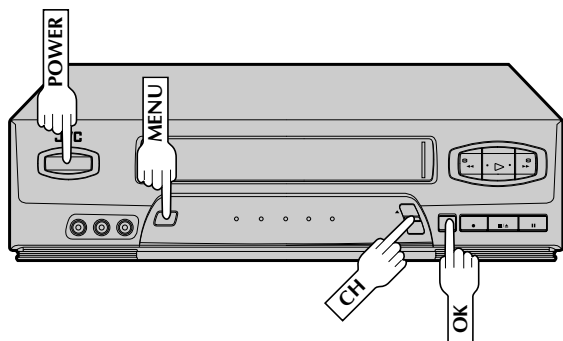

INFORMATION

The VCR detects the band (TV or CATV) and selects the correct band automatically during Auto Channel Set. The selected band will be displayed on the right side of "BAND" on the Tuner Set screen.

Set Receivable Channels

1 TURN ON THE VCR

Press **POWER**.

2 ACCESS MAIN MENU SCREEN

Press **MENU**.

3 ACCESS TUNER SET SCREEN

Move the highlight bar (arrow) to "TUNER SET" by pressing **CH▲▼** or **△▽**, then press **OK** or **▷**.

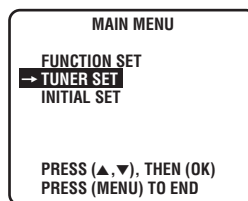

4 PERFORM AUTO CHANNEL SET

Move the highlight bar (arrow) to "AUTO CHANNEL SET" by pressing **CH▲▼** or **△▽**, then press **OK** or **▷**.

- Receivable channels in your area are automatically assigned to the **CH▲▼** buttons, and non-receivable channels are skipped.

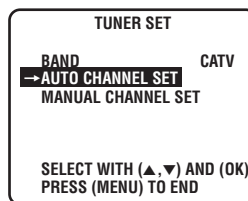

NOTES:

- At the end of Auto Channel Set, "SCAN COMPLETED" appears on screen.
- If the scan was unsuccessful, "SCAN COMPLETED-NO SIGNAL" appears on screen. Check the connections and start again.



5 RETURN TO NORMAL SCREEN

Press **MENU**.

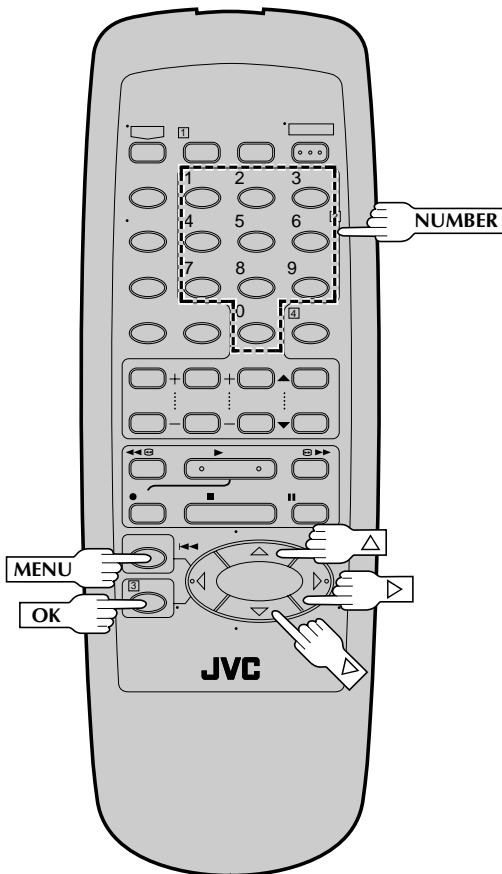
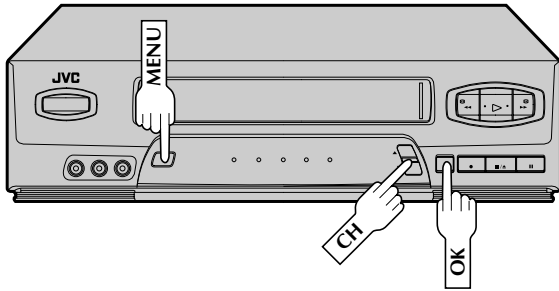

Add Or Delete A Channel

1

ACCESS MAIN MENU SCREEN

Press **MENU**.

2

ACCESS TUNER SET SCREEN

Move the highlight bar (arrow) to "TUNER SET" by pressing **CH▲▼** or **▲▼**, then press **OK** or **▷**.

3

ACCESS MANUAL CHANNEL SET SCREEN

Move the highlight bar (arrow) to "MANUAL CHANNEL SET" by pressing **CH▲▼** or **▲▼**, then press **OK** or **▷**.

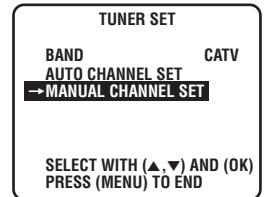

4

ADD OR SKIP DESIRED CHANNEL

Input the channel number using the **NUMBER** keys or by pressing **CH▲▼** or **▲▼**, then press **OK** or **▷** to set to "ADD" or "SKIP" as required. Repeat for each channel you want to add or skip.

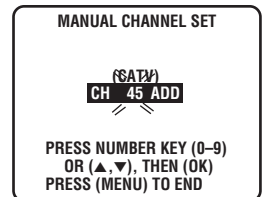

5

RETURN TO NORMAL SCREEN

Press **MENU**.

Simple Playback

Turn on the TV and select the VCR channel 3 or 4 (or AV mode).

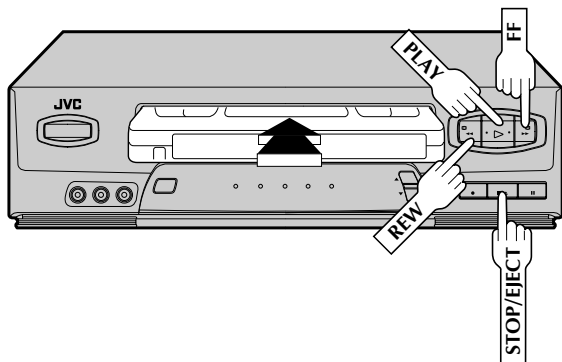

1 LOAD A CASSETTE

Make sure the window side is up, the rear label side is facing you and the arrow on the front of the cassette is pointing towards the VCR. Don't apply too much pressure when inserting.

- The VCR's power comes on automatically.
- The counter is automatically reset to "0:00:00".
- If the cassette's record safety tab has been removed, playback begins automatically.

2 FIND PROGRAM START POINT

If the tape is advanced past the start point, press **REW**. To go forward, press **FF**.

3 START PLAYBACK

Press **PLAY**. "AUTO PICTURE" appears on the screen (when AUTO PICTURE is set to "ON"  pg. 20).

4 STOP PLAYBACK

Press **STOP** or **STOP/EJECT**. Then press **STOP/EJECT** to remove the cassette.

INFORMATION

This video recorder is equipped with SQPB (S-VHS QUASI PLAYBACK) that lets you watch tapes recorded in the S-VHS format with regular VHS resolution.

- SQPB does not deliver Super VHS resolution.
- S-VHS recording is not possible with this video recorder.

Usable cassettes

Full-Size VHS
T-30 (ST-30**)
T-60 (ST-60**)
T-90
T-120 (ST-120**)
T-160 (ST-160**)
ST-210**

Compact VHS*
TC-20 (ST-C20**)
TC-30 (ST-C30**)
TC-40 (ST-C40**)

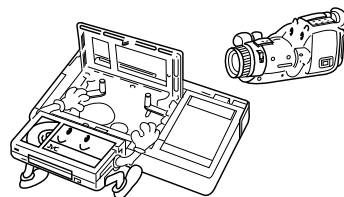

* Compact VHS camcorder recordings can be played on this video recorder. Simply place the recorded cassette into a VHS Cassette Adapter and it can be used just like any full-sized VHS cassette.

** This video recorder can record on regular VHS and Super VHS cassettes. However, it will record regular VHS signals only.

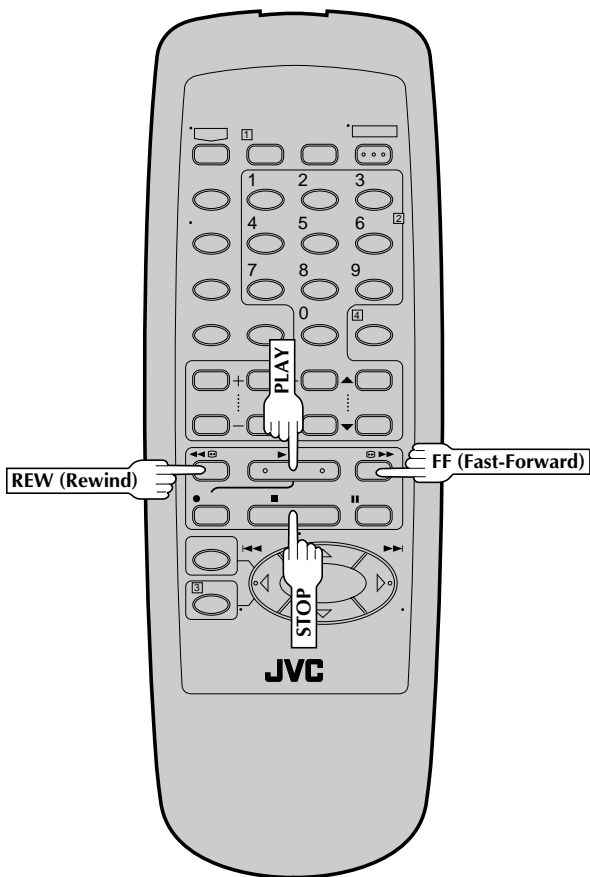

Simple Recording

Turn on the TV and select the VCR channel 3 or 4 (or AV mode).

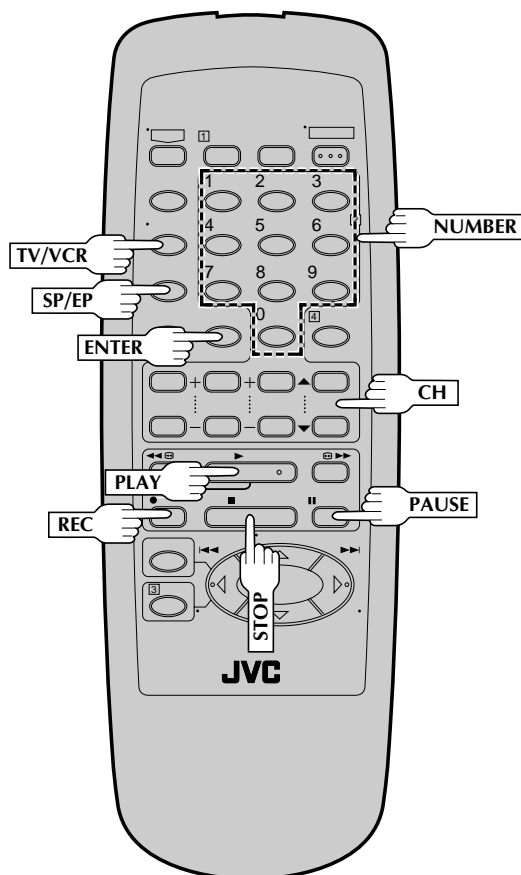
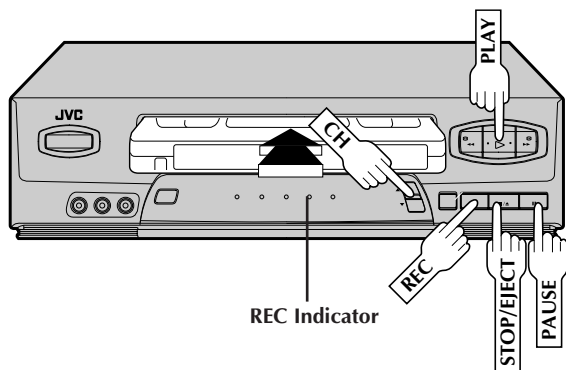

1 LOAD A CASSETTE

Make sure the record safety tab is intact. If not, cover the hole with adhesive tape before inserting the cassette.

2 SELECT RECORDING CHANNEL

Press **CH▲▼**. Or press the appropriate **NUMBER** keys, then press **ENTER**. (The channel changes after a few seconds whether you press **ENTER** or not.)

- If you use the RF connection, by pressing the **TV/VCR** button, select VCR mode to view the program to be recorded.

3 SET TAPE SPEED

Press **SP/EP** to set the recording speed.

4 START RECORDING

Press and hold **REC** and press **PLAY** on the remote control, or press **REC** on the VCR's front panel.

- The REC indicator lights on the front display panel.

5 PAUSE/RESUME RECORDING

Press **PAUSE**. Press **PLAY** to resume recording.

- During record pause, you can change the recording channel by using the **CH▲▼** buttons or **NUMBER** keys.

6 STOP RECORDING

Press **STOP** or **STOP/EJECT**. Then press **STOP/EJECT** to remove the cassette.

Accidental erasure prevention

- To prevent accidental recording on a recorded cassette, remove its record safety tab. To record on it later, cover the hole with adhesive tape.

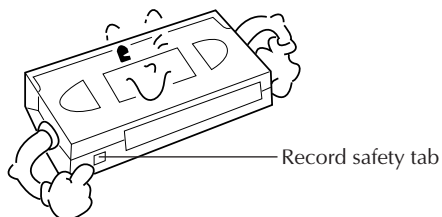

Playback Features

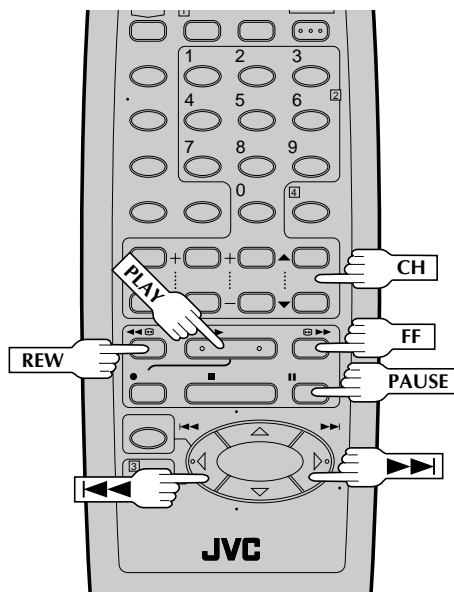
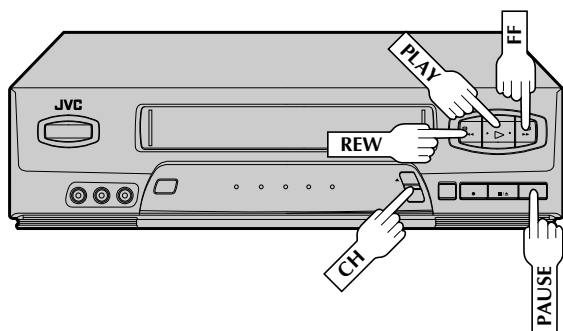

Still Picture/Frame-By-Frame Playback

1 PAUSE DURING PLAYBACK

Press **PAUSE**. If there is vertical jitter, use the **CH** ▲ or ▼ button to correct the picture.

2 ACTIVATE FRAME-BY-FRAME PLAYBACK

Press **PAUSE** repeatedly to advance one frame at a time.

- Reverse frame-by-frame playback is not possible with this recorder.

To resume normal playback, press **PLAY**.

Slow Motion

1 ACTIVATE SLOW-MOTION PLAYBACK

For forward slow motion during still picture, press and hold **PAUSE** for more than 2 seconds. Press **PAUSE** again to return to still picture.

- Reverse slow motion is not possible with this recorder.

To resume normal playback, press **PLAY**.

High-Speed Search

1 ACTIVATE HIGH-SPEED SEARCH

During playback or still, press **FF** for forward high-speed search, or **REW** for reverse high-speed search.

To resume normal playback, press **PLAY**.

NOTE:

For short searches, during playback or still, press and hold **FF** or **REW** for over 2 seconds. When released, normal playback resumes.

Index Search

Index codes are placed on the tape at the start of each recording. You can find and automatically play back from the start of any recording using the Index Search function.

1 START SEARCH

While the tape is stopped, press ◀◀ or ▶▶ (< or >).

2 ACCESS DISTANT CODE

To access a recording 2–9 index codes away, press ◀◀ or ▶▶ (< or >) repeatedly until the correct number is displayed on screen (only if SUPERIMPOSE is set to ON (pg. 18)). Playback begins automatically when the desired recording is located.

- If necessary press **REW** or **FF** when play starts to search visually to find the very beginning of the desired program.

NOTE:

An index code is not placed on the tape when recording is paused and then resumed.

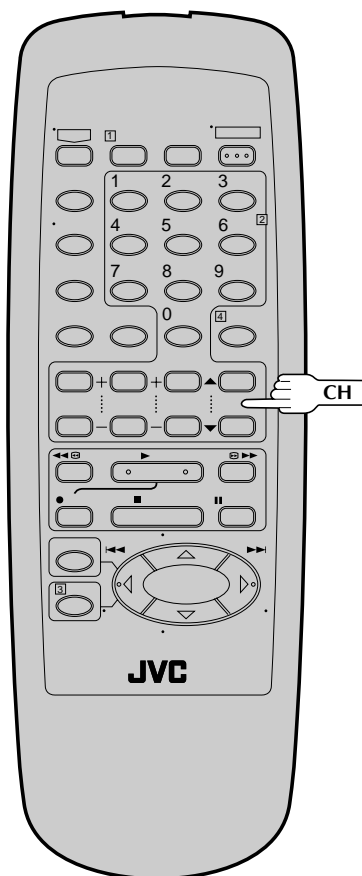
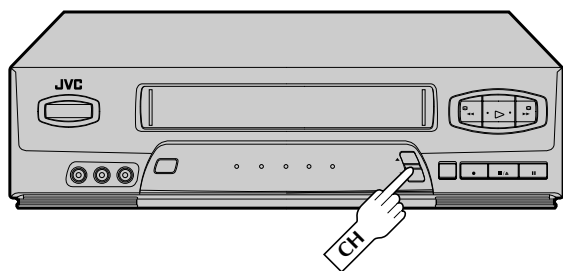

Manual Tracking

Once playback begins, the VCR's automatic tracking function is engaged. If tracking noise appears in the picture, you can override this and make the adjustment manually.

1 ENGAGE MANUAL TRACKING MODE

During playback, press the **CH▲** and **▼** buttons on the VCR's front panel simultaneously to cancel the automatic tracking mode and enable manual tracking adjust.

2 ADJUST MANUAL TRACKING

Press **CH▲** or **▼** on the VCR's front panel or remote. Press briefly for fine adjust, or press and hold for coarse adjust. Watch the screen and continue adjusting until optimum picture and sound quality are achieved.

3 RE-ENGAGE AUTOMATIC TRACKING

Press the **CH▲** and **▼** buttons on the VCR's front panel simultaneously.

- When automatic tracking is re-engaged, Auto Picture is automatically activated.

NOTES:

- To obtain a noiseless still picture it may be necessary to adjust tracking in slow playback and then engage Pause.
- Manual tracking is possible during slow motion. During slow-motion playback, simply press **CH▲** or **▼** on the VCR's front panel or remote to adjust tracking.

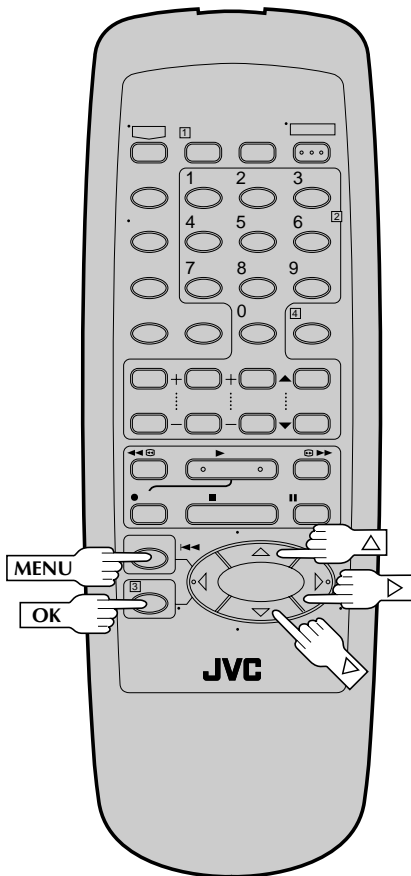
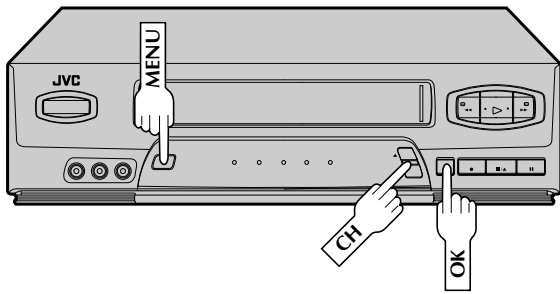

Video Stabilizer

By activating the Video Stabilizer you can correct vertical vibrations in the picture when playing back unstable EP recordings that were made on another VCR. When this function is set to "ON", vertical vibration will be automatically corrected. *The default setting is "OFF".

1 ACCESS MAIN MENU SCREEN

Press MENU.

2 ACCESS FUNCTION SET SCREEN

Move the highlight bar (arrow) to "FUNCTION SET" by pressing CH \blacktriangle or \blacktriangledown , then press OK or \blacktriangleright .

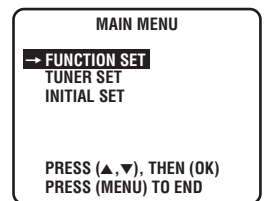

3 ACTIVATE VIDEO STABILIZER

HR-A34U

HR-A54U

FUNCTION	
AUTO TIMER	OFF
SUPERIMPOSE	ON
AUTO SP→EP TIMER	OFF
→ VIDEO STABILIZER	ON
AUTO PICTURE	ON
SELECT WITH (▲, ▼) AND (OK) PRESS (MENU) TO END	

FUNCTION	
AUTO TIMER	OFF
SUPERIMPOSE	ON
AUTO SP→EP TIMER	OFF
→ VIDEO STABILIZER	ON
NEXT PAGE	
SELECT WITH (▲, ▼) AND (OK) PRESS (MENU) TO END	

Move the highlight bar (arrow) to "VIDEO STABILIZER" by pressing CH \blacktriangle or \blacktriangledown , then press OK or \blacktriangleright to set to "ON".

4 RETURN TO NORMAL SCREEN

Press MENU.

NOTES:

- The Superimpose mode indications may jitter vertically when "VIDEO STABILIZER" is set to "ON".
- Regardless of the setting, this function has no effect with SP recordings, during recording and during special-effects playback.
- When you finish viewing the tape, be sure to set it back to "OFF".

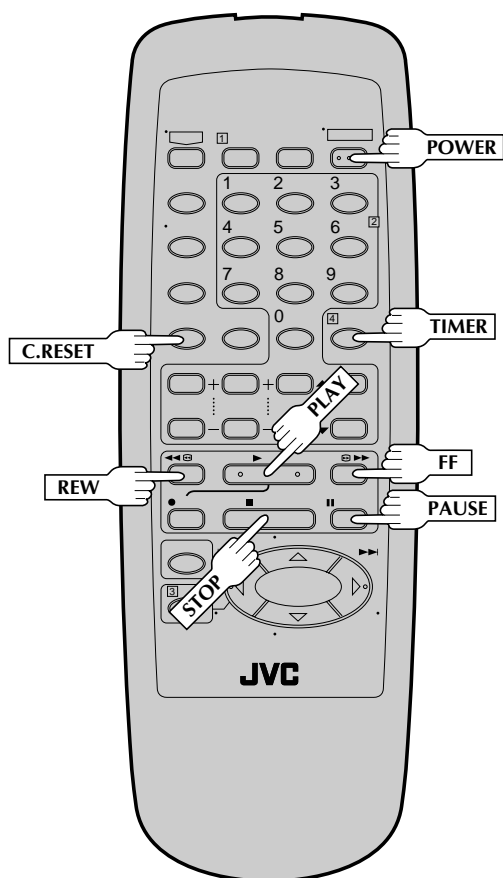
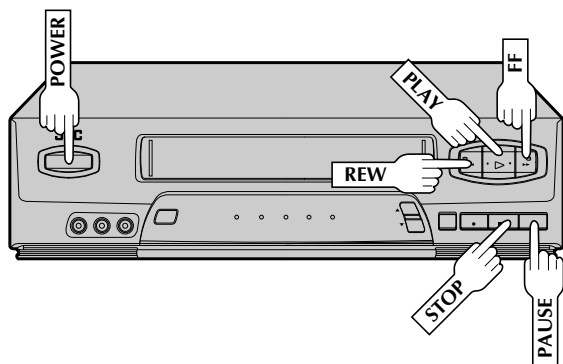

Repeat Playback

1

START REPEAT

Press and hold **PLAY** (until "PLAY" blinks on the screen) during playback, then release.

- The entire tape is played back 50 times.

2

STOP REPEAT

To stop, press **STOP** at any time.

NOTE:

Pressing **PLAY**, **REW**, **FF** or **PAUSE** also stops Repeat Playback.

Counter Reset

1

RESET COUNTER TO ZERO

Press **C.RESET**.

Tape Position Indicator

The Tape position indicator appears on screen when, from the stop mode, you press **FF** or **REW**, or perform an Index Search. The position of "■" in relation to "B" (Beginning) or "E" (End) shows you where you are on the tape.

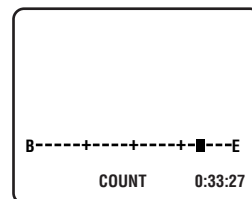

NOTES:

- "SUPERIMPOSE" must be set to "ON", or the indicator will not appear (pg. 18).
- It may take a few seconds for the Tape Position Indicator to be displayed.

Next-Function Memory

The Next Function Memory "tells" the VCR what to do after rewinding. Before continuing, ensure that the VCR is in stop mode.

- a- For Automatic Start Of Playback After Tape Rewind . . .
 . . . press **REW**, then press **PLAY** within 2 seconds.
- b- For Automatic Power Off After Tape Rewind . . .
 . . . press **REW**, then press **POWER** within 2 seconds.
- c- For Automatic Timer Standby After Tape Rewind . . .
 . . . press **REW**, then press **TIMER** within 2 seconds.

NOTE:

It is not possible to select the Automatic Timer functions if the cassette's record safety tab is removed.

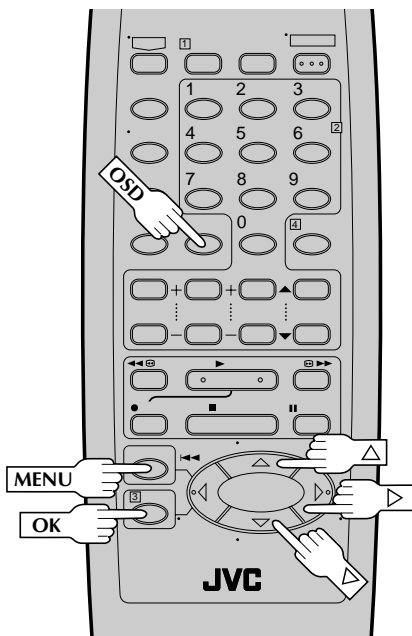
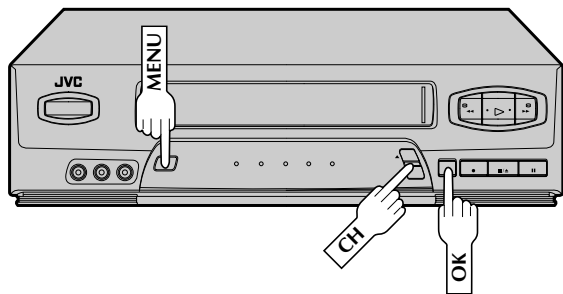

To recall an indication

- 1 Press **OSD**.
 - All indications corresponding to the current status are displayed for 5 seconds. After that, the counter information and RECORD/PAUSE if in the Record Pause mode, are left displayed on the screen.
- 2 Press **OSD** again to clear the display.

Superimpose

This function, switchable between ON and OFF, determines whether or not operational indicators will appear on screen.

1 ACCESS MAIN MENU SCREEN

Press **MENU**.

2 ACCESS FUNCTION SET SCREEN

Move the highlight bar (arrow) to "FUNCTION SET" by pressing **CH▲▼** or **▲▼**, then press **OK** or **▷**.

3 SELECT SUPERIMPOSE SET MODE

HR-A34U		HR-A54U	
FUNCTION		FUNCTION	
AUTO TIMER	OFF	AUTO TIMER	OFF
→ SUPERIMPOSE	ON	→ SUPERIMPOSE	ON
AUTO SP→EP TIMER	OFF	AUTO SP→EP TIMER	OFF
VIDEO STABILIZER	OFF	VIDEO STABILIZER	OFF
AUTO PICTURE	ON	AUTO PICTURE	ON

SELECT WITH (▲,▼) AND (OK) PRESS (MENU) TO END

Move the highlight bar (arrow) to "SUPERIMPOSE" by pressing **CH▲▼** or **▲▼**, then press **OK** or **▷** to select the desired mode:

- a- Select "ON" if you want the superimposed operational indications on the TV screen.
- b- Select "OFF" if you do not want the superimposed operational indications on the screen.

4 RETURN TO NORMAL SCREEN

Press **MENU**.

NOTES:

- If you engage the Record Pause mode, RECORD/PAUSE is displayed regardless of the Superimpose mode setting.
- If you select a channel on which no signal is received, the channel number is displayed regardless of the Superimpose mode setting.

The superimposed indication on the TV screen tells you what the VCR is doing.

Tuned-in channel or AUX(iliary) mode

When the channel is changed, the new channel is displayed on the screen for 5 seconds.

Clock time

Stereo program indication (HR-A54U only)

Second Audio Program indication (HR-A54U only)

Tape position indicator

Audio mode indications (HR-A54U only)

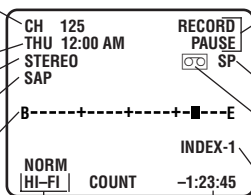

Counter reading

Operation mode

When the operation mode is changed, the new mode is displayed — RECORD (5 sec.), PLAY (5 sec.), FF/REW (5 sec. when engaged from Stop mode), RECORD PAUSE (for as long as Pause is engaged), and ITR *.* (5 sec.).

Tape speed indication

"Cassette Loaded" mark

When a cassette is loaded, the mark is displayed for 5 seconds. It blinks when the VCR's EJECT button is pushed.

INDEX indication

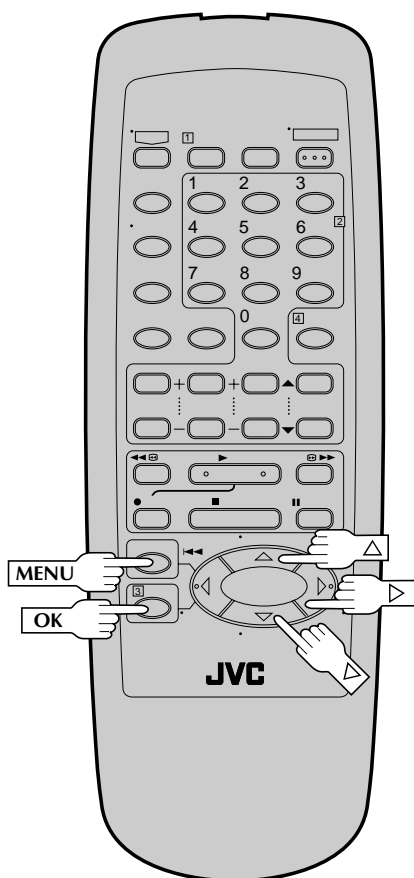
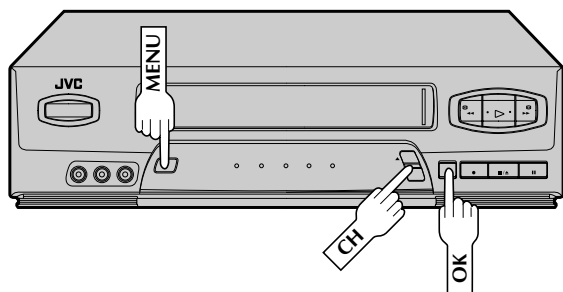

Select The Soundtrack (HR-A54U Only)

Your VCR can record two soundtracks simultaneously (Normal and Hi-Fi) and play back the selected one, or both together. Or, when viewing a pre-recorded tape that contains two separate Hi-Fi audio programs, you can choose to listen to either one by selecting either "Hi-Fi L" or "Hi-Fi R" in step 3.

1 ACCESS MAIN MENU SCREEN

Press MENU.

2 ACCESS FUNCTION SET SCREEN

Move the highlight bar (arrow) to "FUNCTION SET" by pressing CH▲▼ or ▲▼, then press OK or ▷.

3 SELECT AUDIO MONITOR SET MODE

Move the highlight bar (arrow) to "AUDIO MONITOR" by pressing CH▲▼ or ▲▼, then press OK or ▷ to select the desired mode:

- a- Hi-Fi
- b- Hi-Fi L
- c- Hi-Fi R
- d- Normal
- e- Mix

FUNCTION	
→ AUTO TIMER	OFF
SUPERIMPOSE	ON
AUTO SP→EP TIMER	OFF
VIDEO STABILIZER	OFF
NEXT PAGE	
SELECT WITH (▲, ▼) AND (OK) PRESS (MENU) TO END	



PREVIOUS PAGE	
2ND AUDIO RECORD	OFF
→ AUDIO MONITOR	HI-FI
AUTO PICTURE	ON
SELECT WITH (▲, ▼) AND (OK) PRESS (MENU) TO END	

4 RETURN TO NORMAL SCREEN

Press MENU.

NOTES:

- If the tape being played back has no Hi-Fi soundtrack, the Normal soundtrack will be heard no matter what choice you make in step 3.
- If RF connection is used for TV, even if Hi-Fi audio monitor is selected the sound will be mono and will be reproduced in both loudspeakers.

Auto Picture

Turn on the TV and select the VCR channel 3 or 4 (or AV mode).

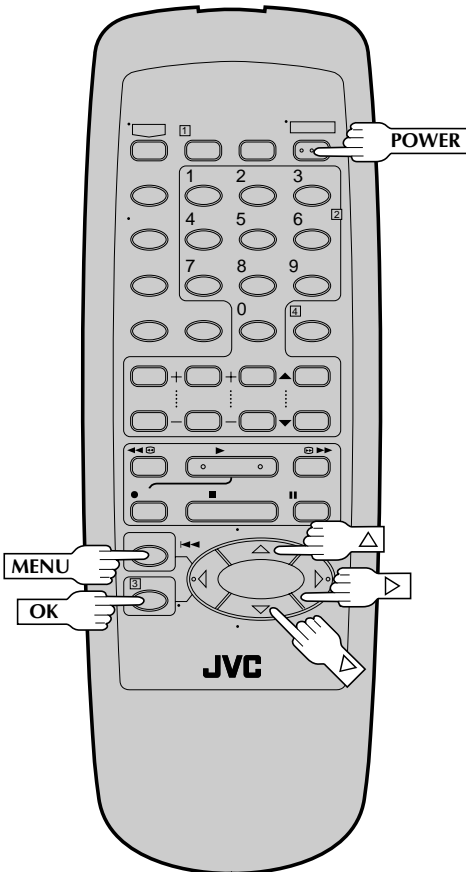
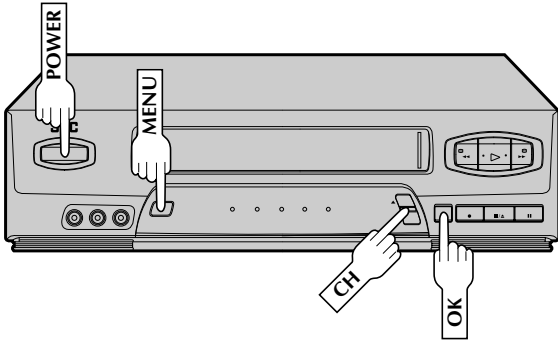

Auto Picture compensates for variations in tape characteristics to ensure the best possible playback picture. It checks and compensates for the condition of the tape at the beginning of automatic tracking when playback is selected. The default setting is "ON".

Preparation

1 TURN ON THE VCR

Press **POWER**.

2 ACCESS MAIN MENU SCREEN

Press **MENU**.

3 ACCESS FUNCTION SET SCREEN

Press **CH** ▲▼ or ▲▼ to move the highlight bar (arrow) to "FUNCTION SET", then press **OK** or ▷.

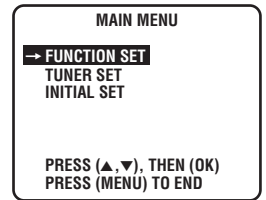

4 SELECT AUTO PICTURE

HR-A34U

FUNCTION

AUTO TIMER	OFF
SUPERIMPOSE	ON
AUTO SP→EP TIMER	OFF
VIDEO STABILIZER	OFF
→ AUTO PICTURE	ON

SELECT WITH (▲,▼) AND (OK)
PRESS (MENU) TO END

HR-A54U

FUNCTION

→ AUTO TIMER	OFF
SUPERIMPOSE	ON
AUTO SP→EP TIMER	OFF
VIDEO STABILIZER	OFF
NEXT PAGE	

SELECT WITH (▲,▼) AND (OK)
PRESS (MENU) TO END

Press **CH** ▲▼ or ▲▼ to move the highlight bar (arrow) to "AUTO PICTURE", then press **OK** or ▷ to set to "ON" or "OFF".

NOTE:

When using rental tapes, or tapes recorded on other VCRs, select "ON" or "OFF" as desired to give the best picture.

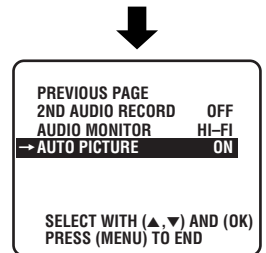

5 RETURN TO NORMAL SCREEN

Press **MENU**.

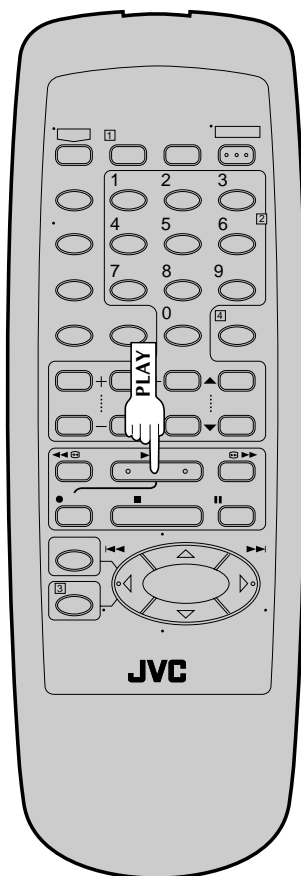
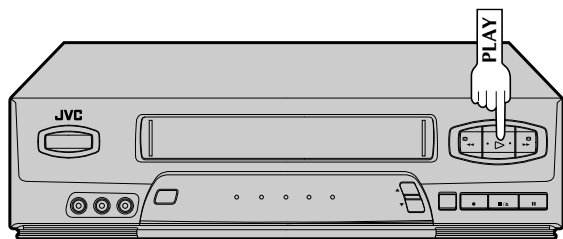

Playback

The VCR assesses the quality of the tape once you start playback.

Perform steps 1 and 2 on page 12 ("Simple Playback") before continuing.

1

START PLAYBACK

Press **PLAY**.

- The VCR adjusts the playback picture quality based on the quality of the tape in use.



NOTES:

- When using rental tapes, or tapes recorded on other VCRs, set "AUTO PICTURE" in step 4 of the Preparation procedure to either "ON" or "OFF" as desired to give the best picture (☞ pg. 20).
- The Auto Picture screen only appears at the beginning of automatic tracking. Even though the screen doesn't appear after that, the Auto Picture function is operative.
- To display the Auto Picture screen, "SUPERIMPOSE" must be set to "ON" or the Auto Picture screen will not appear (☞ pg. 18).

Recording Features

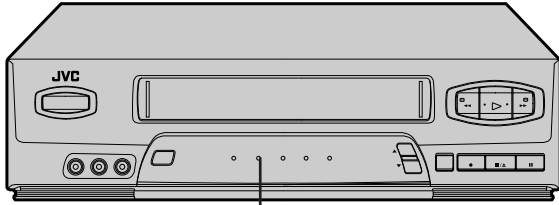

TV/VCR Indicator

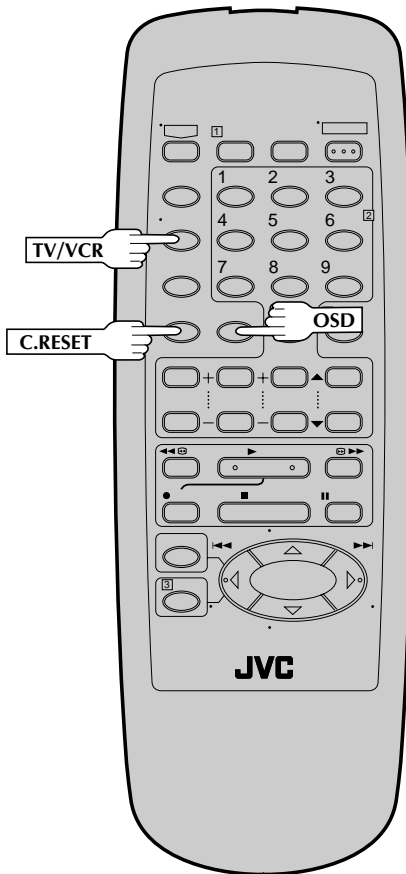

Record One Program While Watching Another

1 ENGAGE TV MODE

During recording...

- Press **TV/VCR**. The VCR's TV/VCR indicator goes out. (If you are using the RF connection (☞ pg. 6) to view the output from your VCR, the TV broadcast being recorded disappears.)
- If you are using the AV connection (☞ pg. 6) to view the output from your VCR, change the TV's input mode from AV to TV.

2 SELECT CHANNEL FOR VIEWING

Use the TV's channel selector to set the channel you want to watch.

Display Elapsed Recording Time

1 RESET COUNTER TO ZERO

Before recording starts, press **C.RESET**. The counter resets to zero and displays the exact elapsed time as the tape runs.

2 DISPLAY ELAPSED TIME ON SCREEN

During recording, press **OSD** at any time to see the elapsed time.

All indications corresponding to the current status of the VCR are displayed for 5 seconds. The counter display remains on the screen indicating the elapsed time. Press **OSD** again to remove the display.

- Make sure "SUPERIMPOSE" is set to "ON" (☞ pg. 18).
- The indications are not recorded.

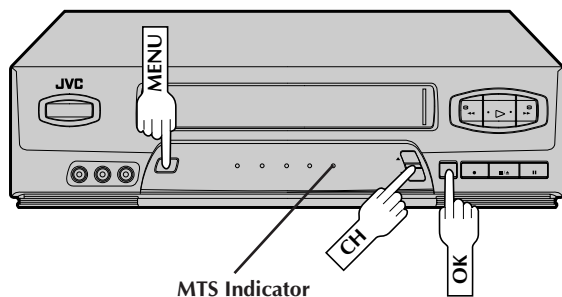

MTS Indicator

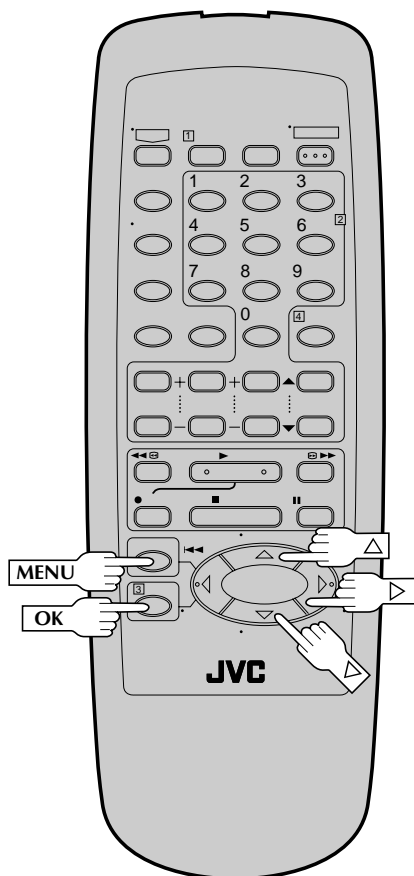

Stereo And SAP (Second Audio Program) (HR-A54U Only)

Your VCR's built-in MTS decoder enables reception of Multi-channel TV Sound broadcasts.

The MTS indicator lights during reception of stereo or SAP broadcasts, and when a stereo program is accompanied by SAP audio.

When the channel is changed...

- The "STEREO" indication appears on the screen for about 5 seconds if the program is a stereo broadcast.
- The "SAP" indication appears on the screen for about 5 seconds if the program is an SAP broadcast.
- Both indications appear when a stereo program is accompanied by SAP audio.

To Record Stereo Programs . . .

. . . simply follow the basic recording procedure.

To Listen To Stereo Soundtrack During Recording . . .

. . . set "AUDIO MONITOR" to "HI-FI" at the Function screen (see pg. 19).

To Record SAP Programs . . .

1 ACCESS MAIN MENU SCREEN

Press MENU.

2 ACCESS FUNCTION SET SCREEN

Move the highlight bar (arrow) to "FUNCTION SET" by pressing CH▲▼ or Δ▽, then press OK or ▷.

3 SELECT 2ND AUDIO RECORD SET MODE

Move the highlight bar (arrow) to "2ND AUDIO RECORD" by pressing CH ▲▼ or Δ▽, then press OK or ▷ to set to "ON".

FUNCTION	
→ AUTO TIMER	OFF
SUPERIMPOSE	ON
AUTO SP→EP TIMER	OFF
VIDEO STABILIZER	OFF
NEXT PAGE	
SELECT WITH (▲, ▼) AND (OK) PRESS (MENU) TO END	



PREVIOUS PAGE	
→ 2ND AUDIO RECORD	ON
AUDIO MONITOR	HI-FI
AUTO PICTURE	ON
SELECT WITH (▲, ▼) AND (OK) PRESS (MENU) TO END	

4 RETURN TO NORMAL SCREEN

Press MENU.

NOTES:

- If a SAP program is received and "2ND AUDIO RECORD" is set to "ON", the SAP audio is recorded on both the Normal and Hi-Fi tracks. The main audio program is not recorded.
- If a non-SAP program is received, the main audio is recorded on both the Hi-Fi and Normal audio tracks.

VCR Plus+ Timer Programming (HR-A54U Only)

Turn on the TV and select the VCR channel 3 or 4 (or AV mode).

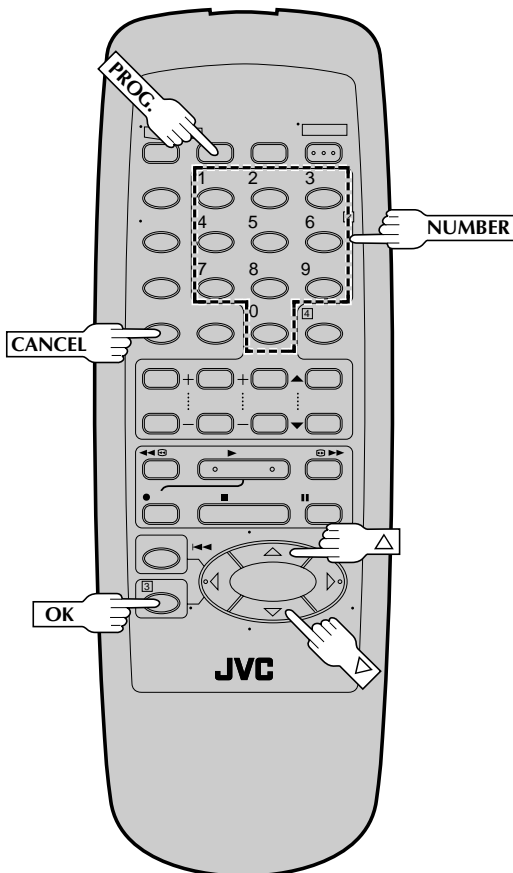
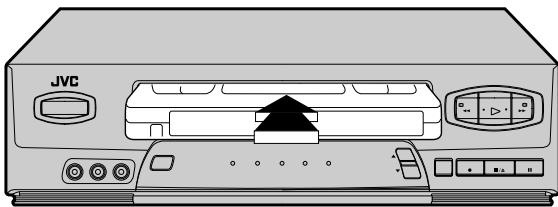

Timer recording allows you to program the VCR to automatically record a program that will be broadcast at some future time. The timer record function can be programmed using VCR Plus+ or Express Timer Programming up to 8 shows as far as a year in advance. (☞ pg. 24 or 28)

The VCR Plus+ timer programming system eliminates the need to input channel, date, start and stop time data when setting the timer record function. Simply key in the PlusCode number for the TV program you wish to record and the VCR's timer will be automatically programmed. (The PlusCodes are the numbers next to the programs in most TV listings.)

LOAD A CASSETTE

Make sure the record safety tab is present.

- The VCR's power comes on automatically.

ACCESS VCR PLUS+ SCREEN

Press **PROG.** on the remote control.

- The clock must be set in order to access the VCR Plus+ screen. If you haven't set the clock, the Main Menu screen appears after an error message is displayed.

Refer to page 9 for the clock setting procedure.

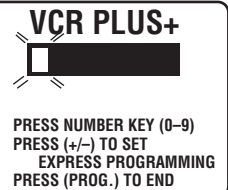

ENTER PLUSCODE NUMBER

Press the appropriate **NUMBER** keys to enter the PlusCode number printed in the TV listings for the TV program you wish to record and press **OK**.

If the Guide Channel Set screen appears, go to step 4.

If the VCR Plus+ Program screen appears, go to step 5.

- To make corrections, press **CANCEL** and input the correct PlusCode number.

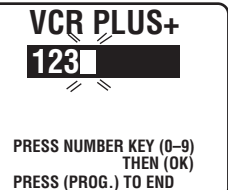

INPUT RECEIVING CHANNEL NUMBER

The Guide Channel Number, which is assigned to the TV or cable station for the PlusCode number that you entered in step 3, will appear automatically on the Guide Channel Set screen. Input the number of the channel on which the broadcast for the PlusCode number is received on the VCR or cable box using the **NUMBER** keys, **CH ▲▼** or **▲▼**, then press **OK**.

- The Guide Channel Set screen appears only when you input the PlusCode number of a station for which the Guide Channel number has not been set already.

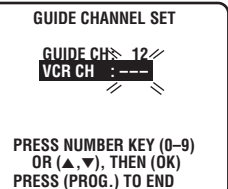

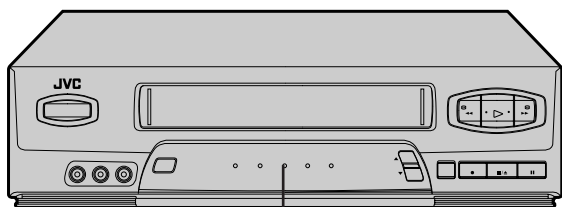

TIMER Indicator

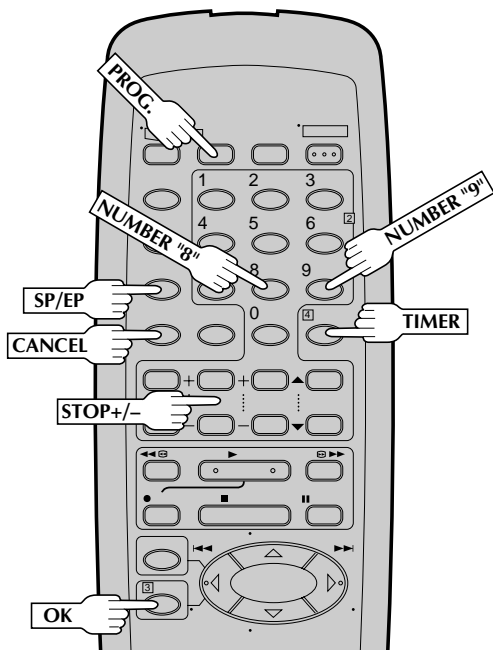

CHECK PROGRAM DATA

5

The PlusCode number you entered and the matching Timer-Recording information is displayed on the Program screen. Check to make sure it's accurate.

PROGRAM 1 (VCR PLUS+ 12345678)	
START	STOP
8:00PM	→ 10:00PM
DATE	CH
12/24/98	12 SP
THU	
PRESS (8=DAILY, 9=WEEKLY STOP +/- = STOP TIME, SP/EP) PRESS (OK) TO END	

- To change the stop time, press **STOP +/-**.
- To timer-record daily or weekly serials, press **DAILY** (NUMBER "8") or **WEEKLY** (NUMBER "9"). "DAILY" or "WEEKLY" appears on the Program screen. Pressing the button again makes each corresponding display disappear.
- If you made a mistake, press **CANCEL** to access the VCR Plus+ screen again and input the correct PlusCode number.
- If the PlusCode number you inputted is incorrect, "ERROR" may appear on the screen to advise you of the error. This happens when the PlusCode number is for a program which has already passed. "ERROR" is displayed for about 5 seconds and the VCR Plus+ screen reappears.

SET TAPE SPEED

Press **SP/EP**.

6

RETURN TO NORMAL SCREEN

Press **PROG.** or **OK**. "PROGRAM COMPLETED" appears on the screen for about 5 seconds, then normal screen appears.

7

ENGAGE TIMER MODE

Press **TIMER**. The VCR turns off automatically and the VCR's **TIMER** indicator lights.

8

ATTENTION

If there is a conflict in the timer schedule and one program overlaps with another, only the parts shown below in gray will be recorded.

Pattern 1: The program with the lower program number will be recorded.

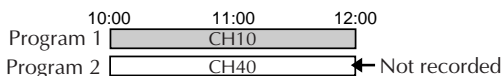

Pattern 2: The program that is broadcast earlier will be recorded.

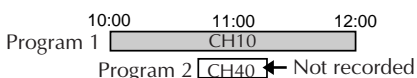

Pattern 3: The program that is broadcast earlier will be recorded, followed by the remaining portion of the other program.

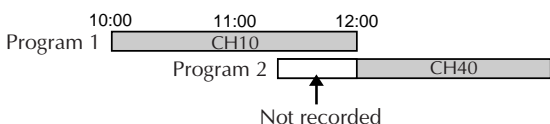

IMPORTANT

If you have moved to a different area or if a broadcasting station's channel number has been changed, the wrong VCR or CABLE CH number will be displayed on the VCR Plus+ Program screen in step 5. When this happens, set the correct the Guide Channel number for that station. (See pg. 26, "VCR Plus+ Setup")

NOTES:

- To disengage the timer before recording starts, press **TIMER** again. Pressing once more re-engages it.
- In case of a power failure after programming, the VCR's memory backup keeps your selections for approximately 3 minutes.
- When timer-recording cable channels received through a Cable Box, be sure to keep the Cable Box set to ON.

VCR Plus+ Setup (HR-A54U Only)

Turn on the TV and select the VCR channel 3 or 4 (or AV mode).

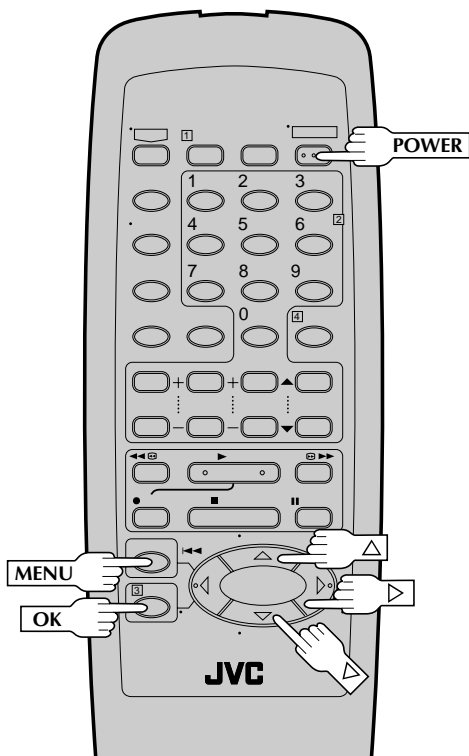
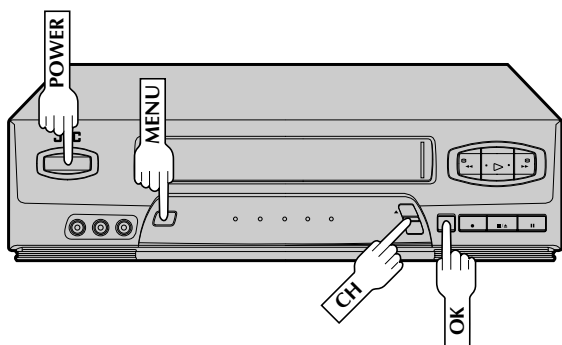

IMPORTANT

If you have moved to a different area or if a broadcasting station's channel number has been changed, the wrong VCR or CABLE CH number will be displayed on the VCR Plus+ Program screen (☞ step 5 on page 25). When this happens, perform the following steps to set the correct the Guide Channel number for that station.

To ensure that VCR Plus+Timer Recording operates correctly it is necessary to set the VCR Plus+ "Guide Channel Set" for each station. Please read the following information carefully.

VCR Plus+ Guide Channel Matching

VCR Plus+ assigns a VCR Plus+ "Guide Channel" to broadcast and cable TV channels. These Guide Channel numbers are also called the VCR Plus+ Channel Codes. Most TV listings have a section, usually a chart, indicating the "Guide Channel" numbers assigned to each station. For accurate VCR Plus+ Programming the VCR Plus+ Guide Channel number for each station should match the channel number on which it is received in your area.

NOTES:

- In many instances the VCR Plus+ Guide Channel numbers for cable and broadcast TV stations **DO NOT** match the channel number on which it is received by your VCR or cable box. Check your TV listing, or contact your cable supplier for details.
- Many broadcast TV stations can be viewed on cable. Check your TV listing, or contact your cable supplier for details.

1 TURN ON THE VCR

Press **POWER**.

2 ACCESS MAIN MENU SCREEN

Press **MENU**.

3 ACCESS INITIAL SET SCREEN

Press **CH▲▼** or **▲▼** to move the highlight bar (arrow) to "INITIAL SET", then press **OK** or **▷**.

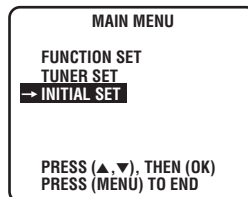

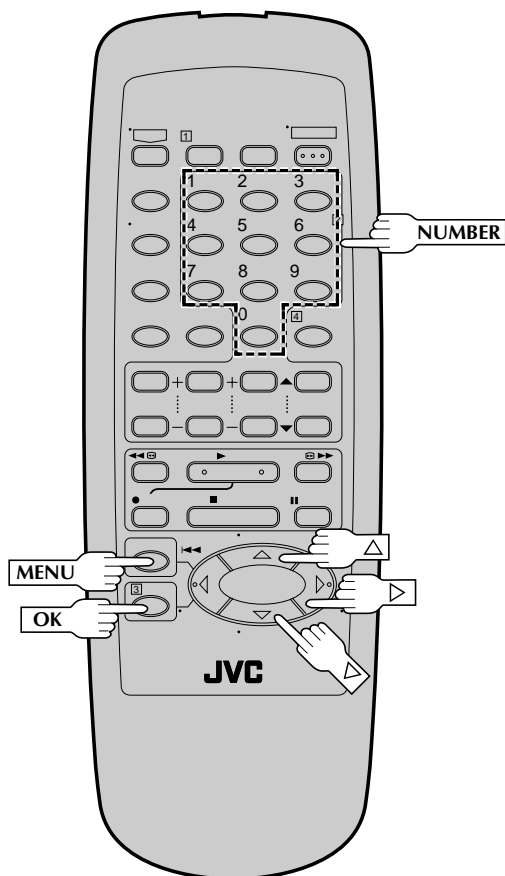
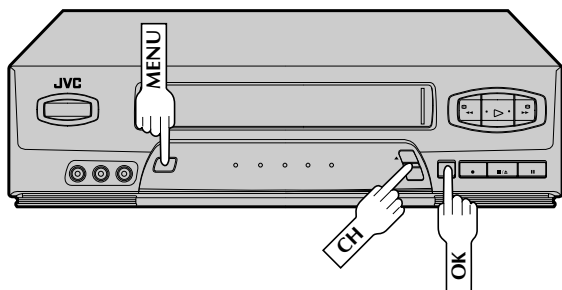

4

ACCESS GUIDE CHANNEL SET SCREEN

Press **CH▲▼** or **▲▼** to move the highlight bar (arrow) to "GUIDE CHANNEL SET", then press **OK** or **▷**.

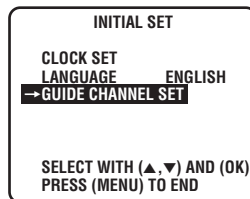

5

INPUT GUIDE CHANNEL NUMBER

Press **CH▲▼**, **▲▼** or the appropriate **NUMBER** keys to input the VCR Plus+ Guide Channel number as shown in the TV listing. Then press **OK** or **▷**.

(Ex.) When inputting the Guide Channel number 6 for WNJU(Ind.)

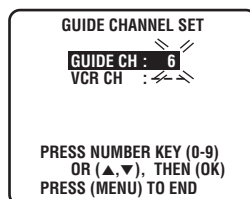

6

INPUT RECEIVING CHANNEL NUMBER

Press **CH▲▼** or the appropriate **NUMBER** keys to input the number of the channel on which the Guide Channel's broadcasts are received. Then press **OK** or **▷**.

(Ex.) If WNJU(Ind.) is received on channel 47

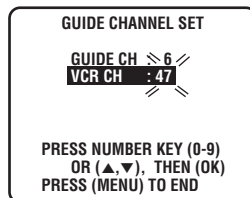

RETURN TO NORMAL SCREEN

Press **MENU**.

7

ATTENTION CABLE BOX SUBSCRIBERS

- In order to set the Guide Channel for a cable program, you must select your cable box's output channel as the VCR channel in step 6. If the cable box is connected to your VCR's ANT. IN connector, select the cable box's RF output channel. If the cable box is connected to your VCR's VIDEO IN and AUDIO IN connectors, press **NUMBER** key "0" to select "F-1" as the VCR channel.
- It is important that you keep the cable box ON and tuned to the cable station of the program you want to record until timer recording is completed.

Express Timer Programming

Turn on the TV and select the VCR channel 3 or 4 (or AV mode).

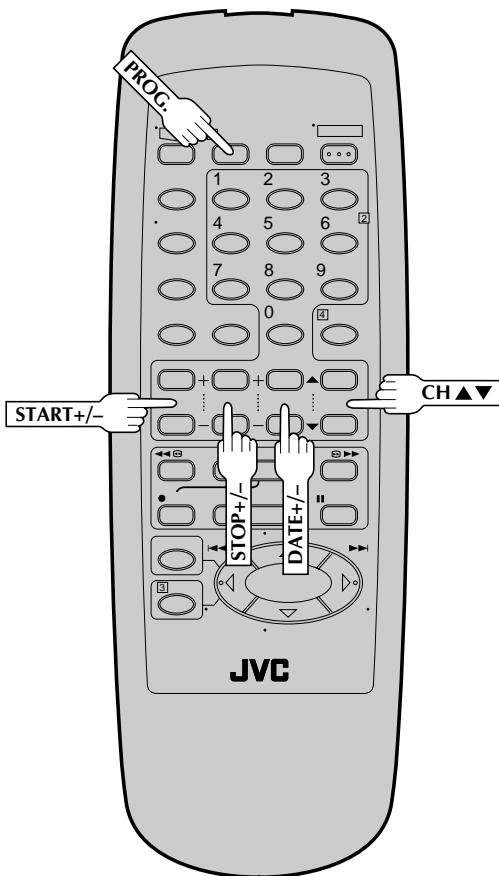
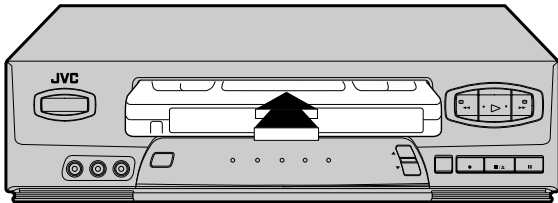

You can directly program the VCR's timer to record up to 8 shows, as far as a year in advance. Remember, the clock must be set before you can program the timer (☞ pg. 9).

1

LOAD A CASSETTE

Make sure the record safety tab is intact. If not, cover the hole with adhesive tape, then load it into the VCR.

- The VCR comes on, and the counter is reset, automatically.

2

ACCESS PROGRAM SCREEN

Press **PROG.**

If you own the HR-A54U, press **PROG.**, then **START +/-**. (If you're just starting out, "PROGRAM 1" appears.)

- The screen to the right appears.

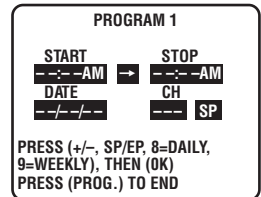

3

SET PROGRAM START TIME

Press **START +/-** to enter the time you want recording to start.

- Press and hold **START +/-** to move in 30-minute increments, or press and release repeatedly to move 1 minute at a time.

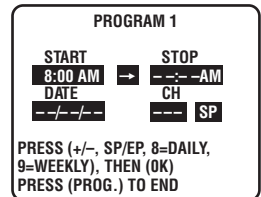

4

SET PROGRAM STOP TIME

Press **STOP +/-** to enter the time you want recording to stop.

- Press and hold **STOP +/-** to move in 30-minute increments, or press and release repeatedly to move 1 minute at a time.

5

SET PROGRAM DATE

Press **DATE +/-**. (The current date is displayed on screen. The date you enter appears in its place.)

6

SET CHANNEL NUMBER

Press **CH ▲▼**.

- Holding down **CH ▲▼** rapidly scans through the channels.
- If you are using a cable box (or DBS receiver), enter the cable box (or DBS receiver) channel, not the channel to be recorded. The channel to be recorded must be selected on the cable box (or DBS receiver). (The cable box (or DBS receiver) channel is the VCR's channel that displays the channels received by the cable box (or DBS receiver).)

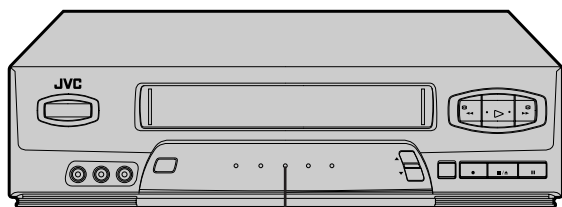

TIMER Indicator

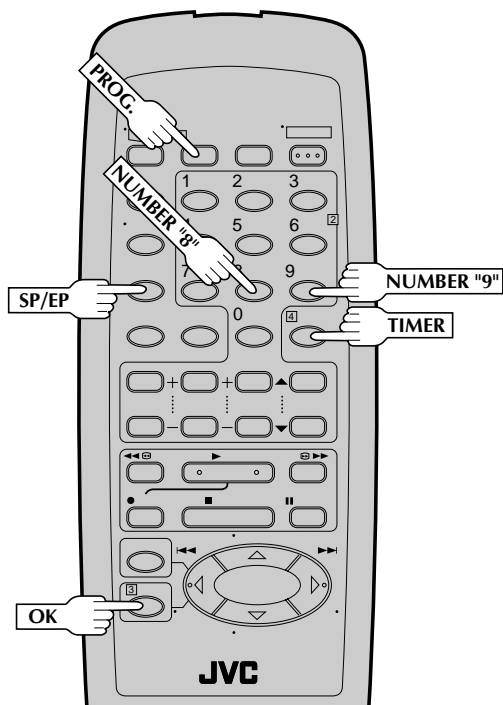

7 SET TAPE SPEED

Press **SP/EP** to set the tape speed.

8 RETURN TO NORMAL SCREEN

Press **PROG.** or **OK**. "PROGRAM COMPLETED" appears on the screen for about 5 seconds, then normal screen appears.

9 ENGAGE TIMER MODE

Press **TIMER**. The VCR turns off automatically and the VCR's **TIMER** indicator lights.

To Timer-Record Weekly Or Daily Serials . . .

. . . anytime during steps 2 through 8, press **WEEKLY** (**NUMBER** key "9") for weekly serials or **DAILY** (**NUMBER** key "8") for daily serials (Monday–Friday). Either "WEEKLY" or "DAILY" appears on the screen. Pressing the button again makes the corresponding indication disappear.

NOTES:

- To disengage the timer before recording starts, press **TIMER** again. Pressing once more re-engages it.
- In case of a power failure after programming, the VCR's memory backup keeps your selections for approximately 3 minutes.
- Programs that start after midnight must have the next day's date.
- After timer recording is completed, the VCR's power goes off automatically.
- You can program the timer while a regular recording is in progress; the on-screen menu will not be recorded.
- If the end of tape is reached during timer recording, the cassette is automatically ejected.
- When timer-recording cable or satellite channels through an external tuner, be sure to keep the cable box or satellite receiver's power ON.

ATTENTION

If there is a conflict in the timer schedule and one program overlaps with another, only the parts shown below in gray will be recorded.

Pattern 1: The program with the lower program number will be recorded.

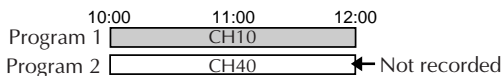

Pattern 2: The program that is broadcast earlier will be recorded.

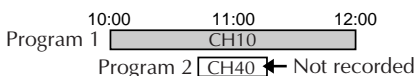

Pattern 3: The program that is broadcast earlier will be recorded, followed by the remaining portion of the other program.

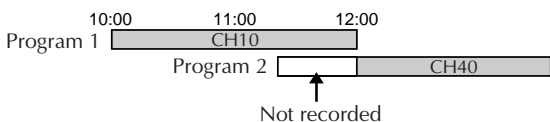

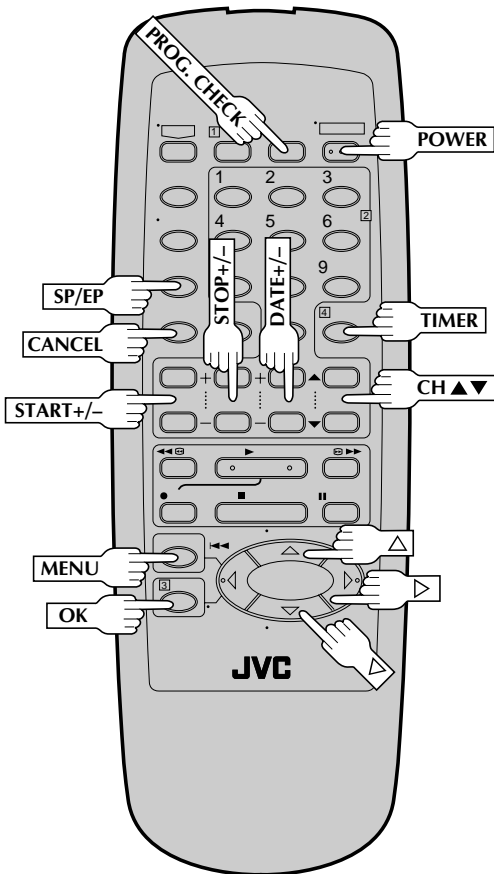
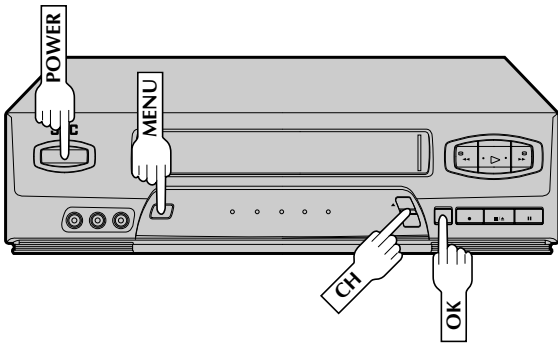

Check, Cancel And Revise Programs

1

DISENGAGE TIMER

Press **TIMER**, then press **POWER**.

2

ACCESS PROGRAM CHECK SCREEN

Press **PROG. CHECK**.

PR	START	STOP	CH	DATE
1	8:00P	10:00	12	12/24
2	10:00A	10:45	40	12/25
3	11:30P	01:00	125	12/25
4				
5				
6				
7				
8				

PRESS (CHECK) TO NEXT

3

ACCESS PROGRAM SCREEN

Press **PROG. CHECK** again to check more information. Each time you press **PROG. CHECK**, the next program's information appears.

To Cancel Or Revise A Program...

4

CANCEL OR REVISE A PROGRAM

To cancel a program, press **CANCEL**.

To revise a program, press the appropriate button: **START+/-**, **STOP+/-**, **DATE+/-**, **CH▲▼**, **SP/EP**.

5

RETURN TO NORMAL SCREEN

Press **PROG. CHECK** as many times as necessary. If there are still programs remaining, go to step 6.

6

RE-ENGAGE TIMER

Press **TIMER**.

Auto SP→EP Timer

If, when recording in SP mode, there is not enough tape to record the entire program, the VCR automatically switches to EP mode to allow complete recording. This feature is especially handy when recording a program of more than 2 hours in length.

For Example . . .

Recording a program of 140 minutes in length onto a 120-minute tape

Approximately 110 minutes Approximately 30 minutes

SP mode	EP mode
---------	---------

Total 140 minutes

Make sure you set "AUTO SP→EP TIMER" to "ON" at the Function screen before the timer recording starts.

1 ACCESS MAIN MENU SCREEN

Press **MENU**.

2 ACCESS FUNCTION SET SCREEN

Move the highlight bar (arrow) to "FUNCTION SET" by pressing **CH ▲▼** or **△▽**, then press **OK** or **▷**.

3 SELECT AUTO SP→EP TIMER SET MODE

HR-A34U

FUNCTION	
AUTO TIMER	OFF
SUPERIMPOSE	ON
→AUTO SP→EP TIMER	ON
VIDEO STABILIZER	OFF
AUTO PICTURE	ON
SELECT WITH (▲,▼) AND (OK) PRESS (MENU) TO END	

HR-A54U

FUNCTION	
AUTO TIMER	OFF
SUPERIMPOSE	ON
→AUTO SP→EP TIMER	ON
VIDEO STABILIZER	OFF
NEXT PAGE	
SELECT WITH (▲,▼) AND (OK) PRESS (MENU) TO END	

Move the highlight bar (arrow) to "AUTO SP→EP TIMER" by pressing **CH ▲▼** or **△▽**, then press **OK** or **▷** to set to "ON".

4 RETURN TO NORMAL SCREEN

Press **MENU**.

NOTES:

- If you have programmed the VCR to timer-record 2 or more programs, the second program and those thereafter may not fit on the tape if you set the Auto SP→EP Timer mode to "ON". In this case, make sure the mode is not engaged, then set the tape speed manually during timer programming.
- In order to ensure that the recording fits on the tape, this feature may leave a slight non-recorded section at the end of the tape.
- There may be some noise at the point on the tape where the VCR switches from SP to EP mode.
- The Auto SP→EP Timer feature is not available during ITR (Instant Timer Recording), and the feature will work with the following tapes: T(ST)-30, T(ST)-60, T(ST)-90, and T(ST)-120.

Auto Timer

When the Auto Timer is set to ON the timer is automatically engaged when the VCR's power is turned off. It is automatically disengaged when the VCR is powered back on.

1 ACCESS MAIN MENU SCREEN

Press **MENU**.

2 ACCESS FUNCTION SET SCREEN

Move the highlight bar (arrow) to "FUNCTION SET" by pressing **CH ▲▼** or **△▽**, then press **OK** or **▷**.

3 SELECT AUTO TIMER SET MODE

HR-A34U

FUNCTION	
→AUTO TIMER	OFF
SUPERIMPOSE	ON
AUTO SP→EP TIMER	OFF
VIDEO STABILIZER	OFF
AUTO PICTURE	ON
SELECT WITH (▲,▼) AND (OK) PRESS (MENU) TO END	

HR-A54U

FUNCTION	
→AUTO TIMER	OFF
SUPERIMPOSE	ON
AUTO SP→EP TIMER	OFF
VIDEO STABILIZER	OFF
NEXT PAGE	
SELECT WITH (▲,▼) AND (OK) PRESS (MENU) TO END	

Move the highlight bar (arrow) to "AUTO TIMER" by pressing **CH ▲▼** or **△▽**, then press **OK** or **▷** to set to "ON" or "OFF".

4 RETURN TO NORMAL SCREEN

Press **MENU**.

NOTE:

For safety, when AUTO TIMER is set to "OFF", all other VCR functions are disabled while the Timer mode is engaged. To disengage the timer, press **TIMER**.

Instant Timer Recording (ITR)

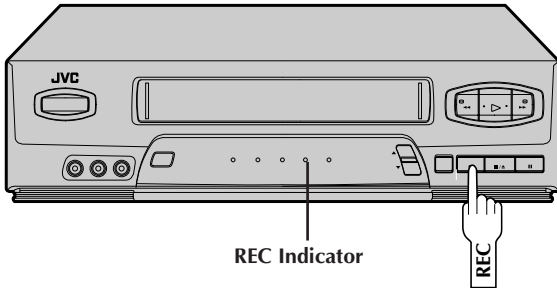

This easy method lets you record from 30 minutes to 6 hours (selectable in 30-min. increments) and shuts the VCR off after recording is finished.

1 START RECORDING

Press **REC** on the front panel.

2 ENGAGE ITR MODE

Press **REC** again. "ITR 0:30" appears on screen and "ITR" blinks for about 5 seconds.

- The REC indicator blinks on the front display panel.

3 SET RECORDING DURATION

If you want to record for more than 30 minutes, press **REC** to extend the time. Each press extends recording time by 30 minutes.

NOTES:

- You can only perform ITR using the **REC** button on the VCR's front panel.
- After you set the ITR time, the previous display reappears.
- To check the remaining time, press **REC** once during recording and the remaining time will be displayed for about 5 seconds. Be careful not to press **REC** again within these 5 seconds, or you will round the recording time up to the next 30 minute increment.

Edit To Another VCR

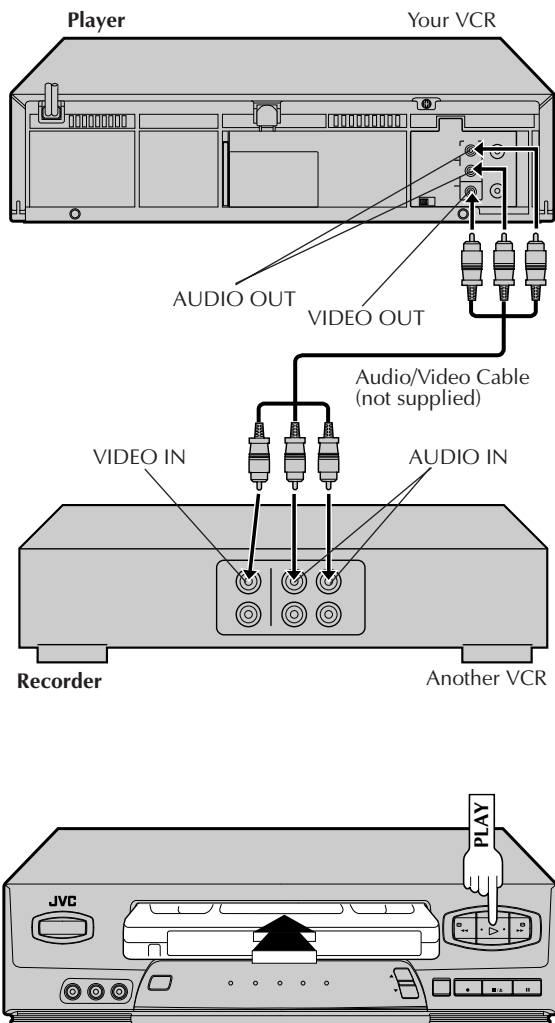

You can use your VCR as the player and another VCR as the recorder.

1 MAKE CONNECTIONS

Connect an AV cable between your VCR's VIDEO OUT and AUDIO OUT connectors and another VCR's VIDEO IN and AUDIO IN connectors.

For HR-A54U owners...

- When connecting to a monaural VCR, connect your VCR's AUDIO OUT L connector to the AUDIO IN connector on the monaural VCR.

For HR-A34U owners...

- When connecting to a Hi-Fi VCR, connect your VCR's AUDIO OUT connector to the AUDIO IN L connector on the Hi-Fi VCR.

2 LOAD CASSETTES

Insert the playback cassette into your VCR and the cassette to be recorded on into the other VCR.

3 SET RECORDER'S INPUT MODE

Set the other VCR's auxiliary (AV) input mode.

4 START PLAYER

Press **PLAY** on your VCR.

NOTE:

*If you don't want to record the superimposed indication on the edited tape, be sure to set "SUPERIMPOSE" to OFF before pressing **PLAY** (pg. 18).*

5 START RECORDER

Set the other VCR to its record mode.

Edit From A Camcorder Or Another VCR

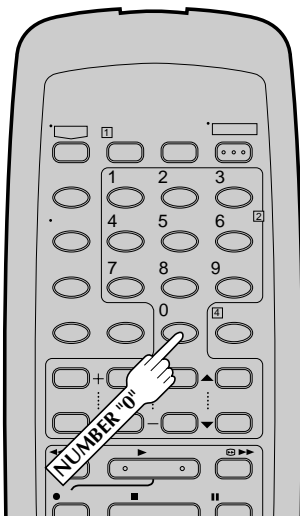
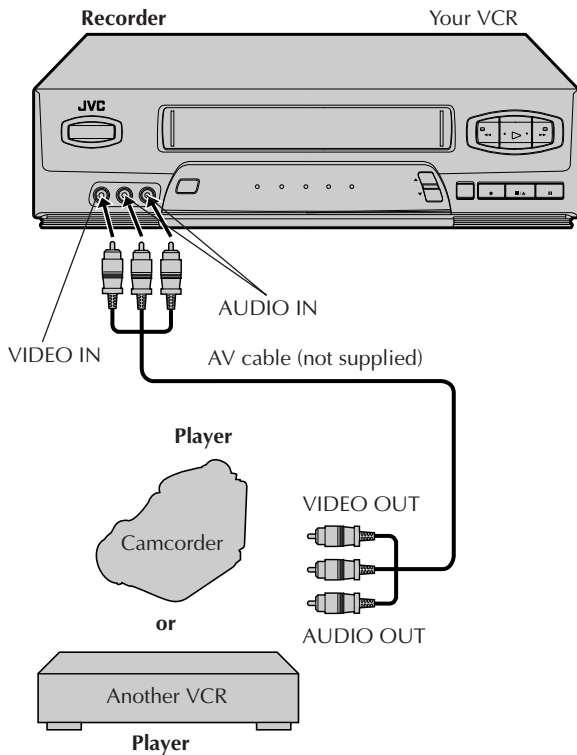

You can use a camcorder or another VCR as the player and your VCR as the recorder.

1 MAKE CONNECTIONS

Connect an AV cable between the camcorder's or the playback VCR's VIDEO OUT and AUDIO OUT connectors and your VCR's VIDEO IN and AUDIO IN connectors.

For HR-A54U owners...

- When using a monaural camcorder or a monaural VCR, connect its AUDIO OUT connector to the AUDIO IN L connector on your VCR.

For HR-A34U owners...

- When using a Hi-Fi camcorder or a Hi-Fi VCR, connect its AUDIO OUT L connector to the AUDIO IN connector on your VCR.

2 LOAD A CASSETTE

Insert the cassette to be recorded on into your VCR and the playback cassette into the camcorder or the playback VCR.

3 SET RECORDER'S INPUT MODE

Press **NUMBER** key "0" to set your VCR to F-1.

4 START PLAYER

Set the camcorder or the playback VCR to its play mode.

NOTE:

If the camcorder or another VCR is equipped with a superimpose/OSD disable feature then set its superimpose or display feature to OFF before pressing play.

5 START RECORDER

Set your VCR to its record mode.

Before requesting service for a problem, use this chart and see if you can repair the trouble yourself. Small problems are often easily corrected, and this can save you the trouble of sending your VCR off for repair.

POWER

SYMPTOM	POSSIBLE CAUSE	CORRECTIVE ACTION
1. The power won't come on.	<ul style="list-style-type: none"> The power cord is disconnected. 	Connect the power cord.
2. The clock works, but the VCR's power won't come on.	<ul style="list-style-type: none"> The TIMER mode is engaged with Auto Timer set to "OFF" (☞ pg. 31). 	Press TIMER to disengage.
3. The remote control won't function.	<ul style="list-style-type: none"> The batteries are discharged. 	Replace the dead batteries with new ones.

TAPE TRANSPORT

SYMPTOM	POSSIBLE CAUSE	CORRECTIVE ACTION
1. The cassette gets stuck partway during loading, and is ejected.	<ul style="list-style-type: none"> The cassette was inserted incorrectly. 	Make sure the cassette's window is facing up, the rear label side is facing you and the arrow on the front of the cassette is pointing towards the VCR. Then insert the cassette.

PLAYBACK

SYMPTOM	POSSIBLE CAUSE	CORRECTIVE ACTION
1. The tape is running but the picture won't appear.	<ul style="list-style-type: none"> If you're using the RF OUT connection (☞ pg. 6), the channel selector on the TV is set incorrectly. If you're using the AV connection (☞ pg. 6), the TV receiver is set to the wrong mode. 	<p>Set the channel selector to channel 3 or 4.</p> <p>Set the TV receiver to its AV mode.</p>
2. Noise appears during visual search.	<ul style="list-style-type: none"> This is normal. 	
3. (HR-A54U only) Breaks are noticeable in Hi-Fi soundtrack.	<ul style="list-style-type: none"> Automatic tracking is engaged. 	Disengage Auto Tracking and adjust the tracking manually (☞ pg. 15).
4. The playback picture is blurred or interrupted, even though TV broadcasts are clear.	<ul style="list-style-type: none"> The video heads may be dirty. 	The heads must be cleaned. Consult your JVC dealer.
5. (HR-A54U only) The Hi-Fi soundtrack cannot be heard.	<ul style="list-style-type: none"> The AUDIO MONITOR option was set incorrectly. 	Set AUDIO MONITOR to "HI-FI" (☞ pg. 19).

RECORDING

SYMPTOM	POSSIBLE CAUSE	CORRECTIVE ACTION
1. Recording won't start.	<ul style="list-style-type: none"> There's no cassette loaded. The loaded cassette has had its record safety tab removed. 	<p>Insert a cassette.</p> <p>Remove the cassette and cover the hole with adhesive tape, or load a cassette on which the record safety tab is intact.</p>
2. TV broadcasts won't record properly.	<ul style="list-style-type: none"> The VCR has been set to its AUX mode by mistake. 	Set the VCR to the appropriate channel.
3. Tape-to-tape editing won't work.	<ul style="list-style-type: none"> The VCRs or the camcorder and the VCR have been incorrectly connected. The power to one or more of the units has not been turned on. The recorder's input mode has been set incorrectly. 	<p>Refer to the directions and the illustration under "Edit To Another VCR" (☞ pg. 33) or "Edit From A Camcorder Or Another VCR" (☞ pg. 34) and properly connect the units. Make sure the power to all units is on.</p> <p>Select the recorder's appropriate input mode.</p>

CONTINUED ON NEXT PAGE

TIMER RECORDING

SYMPTOM	POSSIBLE CAUSE	CORRECTIVE ACTION
1. Timer recording won't work.	<ul style="list-style-type: none"> • The clock and/or the timer have been set incorrectly. • The timer is not engaged. • The VCR has not been set up properly. 	<p>Set the clock and/or timer correctly.</p> <p>Press TIMER and check to make sure that the TIMER indicator on the front panel lights.</p> <p>Re-perform the set-up procedures.</p>
2. Timer programming won't work.	<ul style="list-style-type: none"> • Timer recording is in progress. 	<p>Timer programming can't be performed when timer recording is in progress. Wait until it finishes.</p>
3. The Timer indicator on the front of the VCR won't stop blinking.	<ul style="list-style-type: none"> • The timer is engaged but there's no cassette loaded. • The loaded cassette has had its record safety tab removed. 	<p>Load a cassette with the record safety tab intact, or with the hole covered with adhesive tape.</p> <p>Press TIMER so that the Timer indicator on the front panel goes out, then eject the cassette and cover its hole with adhesive tape, or replace it with a cassette on which the safety tab is intact.</p>
4. The Timer indicator on the front of the VCR blinks for 10 seconds and the timer mode is disengaged.	<ul style="list-style-type: none"> • TIMER has been pressed when there are no programs in memory, or the timer record program information has not been programmed correctly. 	<p>Check the programmed data and re-program as necessary, then press TIMER again.</p>
5. The cassette is automatically ejected, the power shuts off and the Timer indicator on the front of the VCR won't stop blinking.	<ul style="list-style-type: none"> • The end of tape was reached during timer recording. 	<p>The program may not have been recorded in its entirety. Next time make sure you have enough time on the tape to record the entire program.</p>
6. (HR-A54U only) We moved, and now VCR Plus+ doesn't work properly.	<ul style="list-style-type: none"> • The receivable stations in the new area are received on different channels than those in the previous area. 	<p>Re-perform the VCR Plus+ setup procedure (☞ pg. 26).</p>
7. "PROGRAM FULL" is displayed on the screen.	<ul style="list-style-type: none"> • All 8 programs of the VCR's timer memory are used. 	<p>Wait until a space in memory clears, or cancel unnecessary program information (☞ pg. 30).</p>

OTHER PROBLEMS

SYMPTOM	POSSIBLE CAUSE	CORRECTIVE ACTION
1. When scanning channels, some of them are skipped over.	<ul style="list-style-type: none"> • Those channels have been preset to be skipped. 	<p>If you need the skipped channels, restore them (☞ pg. 11).</p>
2. The channel can't be changed.	<ul style="list-style-type: none"> • Recording is in progress. 	<p>Press PAUSE to pause the recording, change channels, then press PLAY to resume recording.</p>

ATTENTION:

This VCR contains microcomputers. External electronic noise or interference can cause microcomputer to malfunction. If the VCR does not operate correctly switch its power off and unplug the power cord from the AC supply. Wait for a while and then plug the power back in. Eject and check the condition of the cassette. If everything appears normal resume operating the VCR as usual.

PLAYBACK

Q. What happens if the end of the tape is reached during playback or search?

A. The tape is automatically rewound to the beginning.

Q. Can the VCR indefinitely remain in the still mode?

A. No. It stops automatically after 5 minutes to protect the heads.

Q. During search, slow, still and frame-by-frame playback, I can't hear any audio. What's the problem?

A. This is normal.

Q. During search, still and frame-by-frame playback, the picture is intermittent. What's the cause?

A. Picture loss occurs when these types of playback are attempted with a tape recorded in LP mode. Pressing **PLAY** to return to normal playback will restore the picture.

Q. When returning from search to normal playback, the picture is disturbed. Should I be concerned about this?

A. No, it is normal.

Q. Noise bars appear during search. What's the problem?

A. This is normal.

Q. When playing back programs that have been timer-recorded with consecutive times (such one program from 8:00 to 9:00 and another one from 9:00 to 10:00), the picture and sound become momentarily distorted at the point where the first program ends and the second program begins. Is this a malfunction?

A. No. This is normal.

Q. Other than preventing further recording, what effect does removing the safety tab have?

A. It disables marking of index codes.

Q. Sometimes, during Index Search, the VCR can't find the program I want to see. Why not?

A. There may be index codes too close together.

Q. During playback, on-screen operational indicators sometimes jitter. Why does this happen?

A. If the condition of the tape being played back is not good, jittering of the video (including on-screen indicators) may occur.

RECORDING

Q. When I pause and then resume a recording, the end of the recording before the pause is overlapped by the new recording. Why does this happen?

A. This is normal. It reduces distortion at the pause and resume points.

Q. Can the VCR indefinitely remain in the Record-Pause mode?

A. No. The VCR automatically goes to its Stop mode after 5 minutes to protect the heads. When paused during Instant Timer Recording (ITR), the VCR shuts off automatically after 5 minutes.

Q. What happens if the tape runs out during recording?

A. The VCR automatically rewinds it to the beginning.

TIMER RECORDING

Q. The REC and TIMER indicators on the front panel remain lit. Is there a problem?

A. No. This is a normal condition for a timer recording in progress.

Q. Can I program the timer while I'm watching a tape or a TV broadcast?

A. Yes, but while you are setting the timer you won't see the tape's or broadcast program's picture as it is replaced by the on-screen menu. The audio from the tape or broadcast program will be present during the setting of the timer.

List Of Terms

This guide serves as a quick way to locate frequently used terms and on-screen display names.

A

Add Channel	11
Audio Monitor	19
Auto Channel Setting	10
Auto Daylight Saving Time	9
Auto Picture	20
Auto SP→EP Timer	31
Auto Timer	31
Automatic Tracking	15
Aux Input	33
AV Connection	6

B

Band	10
------------	----

C

Cancel Program	30
Cassette Adapter.....	12
Check Program	30
Clock Setting	9
Connection to TV	6
Contents.....	5
Counter Reset.....	17

D

Delete Channel	11
----------------------	----

E

Editing.....	33
Express Timer Programming	28
Express Timer Recording	28

F

Frame-by-Frame Playback	14
-------------------------------	----

G

Guide Channel Setting	27
-----------------------------	----

I

Index Search	14
Insert Cassette	12
ITR (Instant Timer Recording)	32

L

Language Selection	8
--------------------------	---

M

Main Menu	8
Manual Channel Setting	11
Manual Tracking	15

N

Next-Function Memory	17
----------------------------	----

O

On-Screen Display	18
-------------------------	----

P

Playback	12
----------------	----

R

Record Safety Tab	13
Recording	13
Repeat Playback.....	17
RF Connection	6

S

SAP (Second Audio Program)	23
Second Audio	23
Slow Motion Playback	14
Specifications	41
SQPB (S-VHS Quasi Play Back)	12
Still Picture Playback	14
Superimpose	18

T

Tape Position Indicator	17
Tape Speed Setting	13
Tuner Setting	10

V

VCR Plus+ Timer Programming	24
VCR Plus+ Timer Recording	24
Video Stabilizer	16

FRONT VIEW

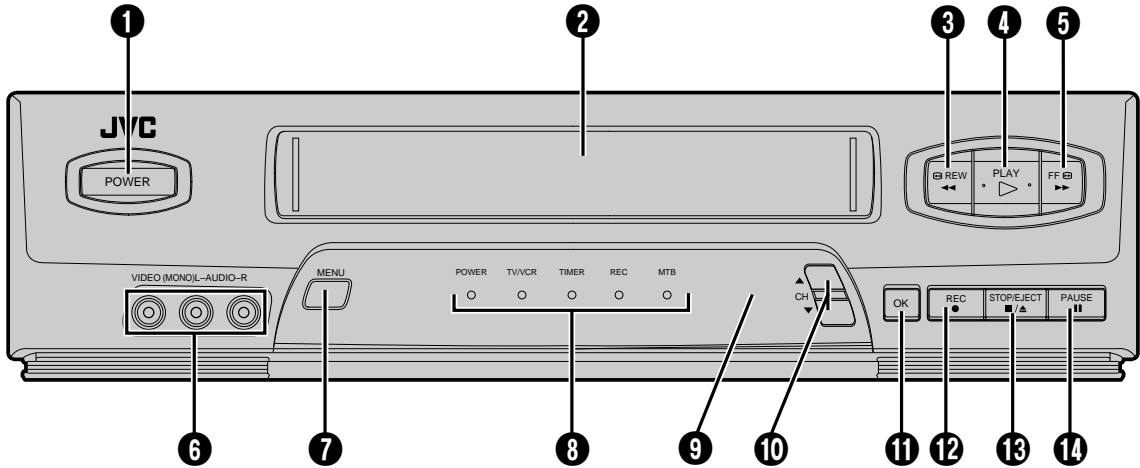

- ❶ Power On/Off Button (☞ pg. 8)
- ❷ Cassette Loading Slot
- ❸ Rewind [REW] Button (☞ pg. 12)
- ❹ PLAY Button (☞ pg. 12)
- ❺ Fast-Forward [FF] Button (☞ pg. 12)
- ❻ VIDEO/AUDIO Input Connectors (☞ pg. 34)
- * The HR-A34U has only one AUDIO input connector.
- ❼ MENU Button (☞ pg. 8)
- ❽ Front Panel Indicators (See below)
- ❾ Remote Control Sensor
- ❿ Channel [CH] ▲▼ Button (☞ pg. 13)
- ⓫ OK Button (☞ pg. 8)
- ⓬ Record [REC] Button (☞ pg. 13)
- ⓭ STOP/EJECT Button (☞ pg. 12)
- ⓮ PAUSE Button (☞ pg. 14)

FRONT PANEL INDICATORS

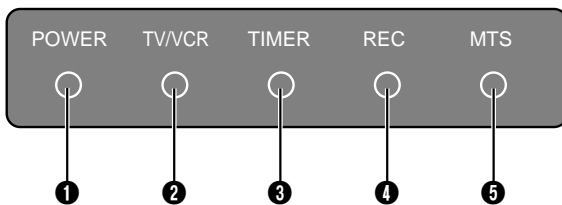

- ❶ Power Indicator
- ❷ VCR Mode Indicator (☞ pg. 22)
- ❸ Timer Mode Indicator (☞ pg. 25)
- ❹ Recording Mode Indicator (☞ pg. 13)
- ❺ Multichannel TV Sound Indicators (HR-A54U only)(☞ pg. 23)

REAR VIEW

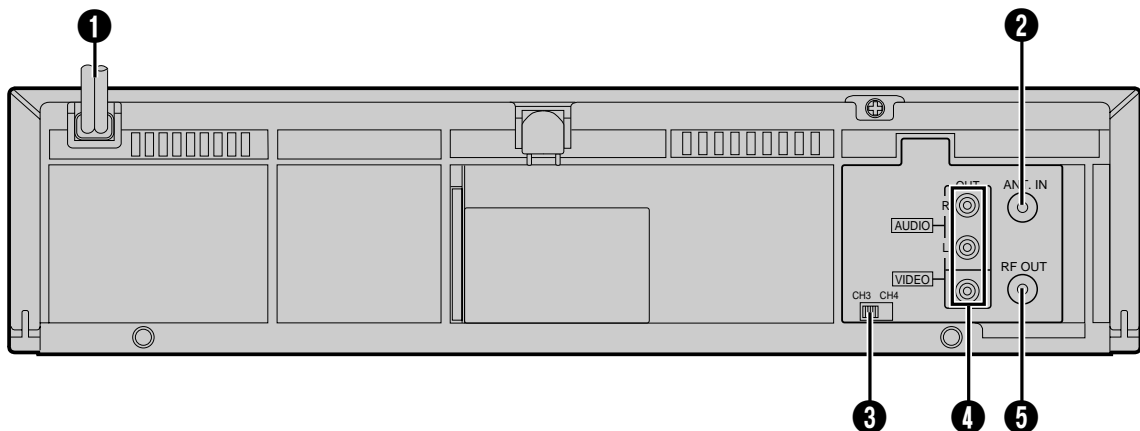

- ❶ Power Cord (☞ pg. 6)
- ❷ ANT. IN Connector (☞ pg. 6)
- ❸ Channel 3/4 Switch (☞ pg. 6)
- ❹ VIDEO/AUDIO Output Connectors (☞ pg. 33)
- * The HR-A34U has only one AUDIO output connector.
- ❺ RF OUT Connector (☞ pg. 6)

REMOTE CONTROL

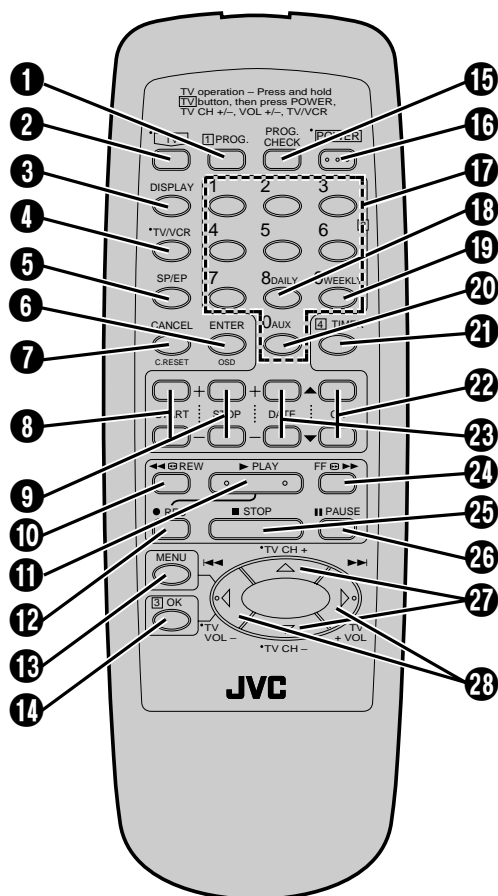

- 1 PROG. Button (☞ pg. 24, 28)
- 2 TV Button (See below)
- 3 DISPLAY Button (No Function)
- 4 TV/VCR Button (☞ pg. 22)
- 5 Recording Speed [SP/EP] Button (☞ pg. 13)
- 6 ENTER Button (☞ pg. 13)
- 7 On-Screen Display [OSD] Button (☞ pg. 18)
- 8 CANCEL Button (☞ pg. 30)
- 9 Counter [C.] RESET Button (☞ pg. 17)
- 10 START +/- Button (☞ pg. 28)
- 11 STOP +/- Button (☞ pg. 28)
- 12 Rewind [REW] Button (☞ pg. 12)
- 13 PLAY Button (☞ pg. 12)
- 14 Record [REC] Button (☞ pg. 13)
- 15 MENU Button (☞ pg. 8)
- 16 OK Button (☞ pg. 8)
- 17 PROG. CHECK Button (☞ pg. 30)
- 18 POWER On/Off Button (☞ pg. 8)
- 19 NUMBER Buttons (☞ pg. 13, 24)
- 20 DAILY Timer Recording Button (☞ pg. 25, 29)
- 21 WEEKLY Timer Recording Button (☞ pg. 25, 29)
- 22 "AUX" Mode Select Button (☞ pg. 34)
- 23 TIMER Button (☞ pg. 25, 29)
- 24 Channel [CH] ▲▼ Button (☞ pg. 13, 29)
- 25 DATE +/- Button (☞ pg. 28)
- 26 Fast-Foward [FF] Button (☞ pg. 12)
- 27 STOP Button (☞ pg. 12)
- 28 PAUSE Button (☞ pg. 14)
- △▽ Button (☞ pg. 8)
- TV Channel [CH] +/- Button (See below)
- ◀▶▶▶▶▶ (◁▷) Button (☞ pg. 14)
- TV Volume [VOL] +/- Button (See below)

Buttons with a small dot on the left side of the name can also be used to operate your JVC TV while holding down the TV button.

Installing Batteries

- 1 Open the battery compartment cover.
- 2 Insert 2 "AA"-size batteries (provided) in the direction indicated under the battery cover.
- 3 Replace the cover.

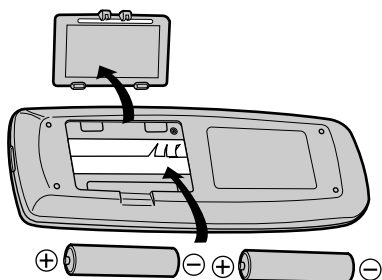

How To Use

The remote control can operate most of your VCR's functions.

- 1 Point the remote control toward the sensor window.
- 2 Press the appropriate operation button.
- 3 The maximum operating distance of the remote control is about 8 m.

Operating JVC TVs

To operate your TV, while holding down TV, press the corresponding button: POWER, TV/VCR, TV CH +/-, TV VOL +/- can be used without holding down TV.

NOTES:

- Depending on the type of JVC TV, there may be cases where some or all functions cannot be operated using the remote control.
- If the remote control doesn't work properly, remove its batteries, wait a short time, replace the batteries and then try again.

GENERAL

Power requirement	: AC 120 V \sim , 60 Hz
Power consumption	
Power on	: 22 W (HR-A54U) : 20 W (HR-A34U)
Power off	: 2 W
Temperature	
Operating	: 5°C to 40°C (41°F to 104°F)
Storage	: -20°C to 60°C (-4°F to 140°F)
Operating position	: Horizontal only
Dimensions (W x H x D)	: 360 x 94 x 273 mm (14-3/16" x 3-3/4" x 10-3/4")
Weight	: 3.0 kg (6.6 lbs)
Format	: VHS NTSC standard
Maximum recording time	
SP	: 210 min. with ST-210 video cassette
EP	: 630 min. with ST-210 video cassette

VIDEO/AUDIO

Signal system	: NTSC-type color signal and EIA monochrome signal, 525 lines/60 fields
Recording/ Playback system	: DA-4 (Double Azimuth) head helical scan system
Signal-to-noise ratio	: 45 dB
Horizontal resolution	: 240 lines
Frequency range	
Normal audio	: 70 Hz to 10,000 Hz
Hi-Fi audio (HR-A54U only)	: 20 Hz to 20,000 Hz
Input/Output	: RCA connectors (IN x 1, OUT x 1)

TUNER

Tuning system	: Frequency-synthesized tuner
Channel coverage	
VHF	: Channels 2-13
UHF	: Channels 14-69
CATV	: 113 Channels
RF output	: Channel 3 or 4 (switchable; preset to Channel 3 when shipped) 75 ohms, unbalanced

TIMER

Clock reference	: Quartz
Program capacity	: 1-year programmable timer/ 8 programs
Memory backup time	: Approx. 3 min.

ACCESSORIES

Provided accessories	: RF cable (F-type), Infrared remote control unit, "AA" battery x 2
----------------------	---

*Specifications shown are for SP mode unless otherwise specified.
E. & O.E. Design and specifications subject to change without notice.*

HOW TO LOCATE YOUR JVC SERVICE CENTER**TOLL FREE: 1-800-252-5722****Dear customer:**

In order to receive the most satisfaction from your purchase, read the instruction booklet before operating the unit. In the event that repair is necessary, or for the address nearest your location, please refer to the factory service center list below or within the Continental United States, call 1-800-252-5722 for your authorized servicer. Remember to retain your Bill of Sale for Warranty Service.

— JVC

**JVC SERVICE & ENGINEERING
COMPANY OF AMERICA
DIVISION OF US JVC CORP.**

FACTORY SERVICE CENTER LOCATIONS

107 Little Falls Road
Fairfield, NJ 07004-2105
(973) 808-9279

1500 Lakes Parkway
Lawrenceville, GA 30243-5857
(770) 339-2522

705 Enterprise Street
Aurora, IL 60504-8135
(630) 851-7855

5665 Corporate Avenue
Cypress, CA 90630-4727
(714) 229-8011

10700 Hammerly Boulevard, Suite 110
Houston, TX 77043-2310
(713) 935-9331

2969 Mapunapuna Place, Suite 101
Honolulu, HI 96819-2000
(808) 833-5828

230 Eliot Street
Ashland, MA 01721-2377
(508) 881-5923

8192 W State Road 84
Davie, FL 33324-4611
(954) 472-1960

890 Dubuque Avenue
South San Francisco, CA 94080-1804
(415) 871-2666

Sophisticated electronic products may require occasional service. Just as quality is a keyword in the engineering and production of the wide array of JVC products, service is the key to maintaining the high level performance for which JVC is world famous. The JVC service and engineering organization stands behind our products.

NATIONAL HEADQUARTERS
JVC SERVICE & ENGINEERING COMPANY OF AMERICA
DIVISION OF US JVC CORP.
107 Little Falls Road
Fairfield, NJ 07004-2105

If you ship the product...

Pack your JVC unit in the original carton or one of equivalent size and strength. Enclose, with the unit, a letter stating the problem or symptom that exists and also a copy of the receipt or bill of sale you received when you purchased your JVC unit. Print your home return address on the outside and the inside of the carton. Send to the appropriate JVC Factory Service Center as listed above.

Don't service it yourself.**CAUTION**

To prevent electrical shock, do not open the cabinet. No user serviceable parts inside.
Refer servicing to qualified service personnel.

ACCESSORIES

To purchase accessories for your JVC product, you may contact your local JVC Dealer.
Or from the 48 Continental United States call toll free:
1-800-882-2345.

LIMITED WARRANTY

CONSUMER VIDEO 1-90

JVC COMPANY OF AMERICA warrants this product and all parts thereof, except as set forth below ONLY TO THE ORIGINAL PURCHASER AT RETAIL to be FREE FROM DEFECTIVE MATERIALS AND WORKMANSHIP from the date of original retail purchase for the period as shown below. ("The Warranty Period")

PARTS	1 YR	LABOR	90 DAYS
-------	-------------	-------	----------------

THIS LIMITED WARRANTY IS VALID ONLY IN THE FIFTY (50) UNITED STATES, THE DISTRICT OF COLUMBIA AND IN COMMONWEALTH OF PUERTO RICO.

WHAT WE WILL DO:

If this product is found to be defective, JVC will repair or replace defective parts at no charge to the original owner. Such repair and replacement services shall be rendered by JVC during normal business hours at JVC authorized service centers. Parts used for replacement are warranted only for the remainder of the Warranty Period. All products and parts thereof may be brought to a JVC authorized service center on a carry-in basis except for Television sets having a screen size 25 inches and above which are covered on an in-home basis.

WHAT YOU MUST DO FOR WARRANTY SERVICE:

Return your product to a JVC authorized service center with a copy of your bill of sale. For your nearest JVC authorized service center, please call toll free: (800) 252-5722.

If service is not available locally, box the product carefully, preferably in the original carton, and ship, insured, with a copy of your bill of sale plus a letter of explanation of the problem to the nearest JVC Factory Service Center, the name and location of which will be given to you by the toll-free number.

If you have any questions concerning your JVC Product, please contact our Customer Relations Department.

WHAT IS NOT COVERED:

This limited warranty provided by JVC does not cover:

1. Products which have been subject to abuse, accident, alteration, modification, tampering, negligence, misuse, faulty installation, lack of reasonable care, or if repaired or serviced by anyone other than a service facility authorized by JVC to render such service, or if affixed to any attachment not provided with the products, or if the model or serial number has been altered, tampered with, defaced or removed;
2. Initial installation and installation and removal for repair;
3. Operational adjustments covered in the Owner's Manual, normal maintenance, video and audio head cleaning;
4. Damage that occurs in shipment, due to act of God, and cosmetic damage;
5. Signal reception problems and failures due to line power surge;
6. Video Pick-up Tubes/CCD Image Sensor, Cartridge, Stylus (Needle) are covered for 90 days from the date of purchase;
7. Accessories;
8. Batteries (except that Rechargeable Batteries are covered for 90 days from the date of purchase); from the date of purchase);

There are no other express warranties except as listed above.

THE DURATION OF ANY IMPLIED WARRANTIES INCLUDING THE IMPLIED WARRANTY OF MERCHANTABILITY, IS LIMITED TO THE DURATION OF THE EXPRESS WARRANTY HEREIN.

JVC SHALL NOT BE LIABLE FOR THE LOSS OF USE OF THE PRODUCT, INCONVENIENCE, LOSS OR ANY OTHER DAMAGES, WHETHER DIRECT, INCIDENTAL OR CONSEQUENTIAL (INCLUDING, WITHOUT LIMITATION, DAMAGE TO TAPES, RECORDS OR DISCS) RESULTING FROM THE USE OF THIS PRODUCT, OR ARISING OUT OF ANY BREACH OF THIS WARRANTY. ALL EXPRESS AND IMPLIED WARRANTIES, INCLUDING THE WARRANTIES OF MERCHANTABILITY AND FITNESS FOR PARTICULAR PURPOSE, ARE LIMITED TO THE WARRANTY PERIOD SET FORTH ABOVE.

Some states do not allow the exclusion of incidental or consequential damages or limitations on how long an implied warranty lasts, so these limitations or exclusions may not apply to you. This warranty gives you specific legal rights and you may also have other rights which vary from state to state.

JVC COMPANY OF AMERICA
DIVISION OF US JVC CORP.

41 Slater Drive
Elmwood Park, New Jersey 07407

REFURBISHED PRODUCTS CARRY A SEPARATE WARRANTY, THIS WARRANTY DOES NOT APPLY. FOR DETAILS OF REFURBISHED PRODUCT WARRANTY, PLEASE REFER TO THE REFURBISHED PRODUCT WARRANTY INFORMATION PACKAGED WITH EACH REFURBISHED PRODUCT.

For customer use:

Enter below the Model No. and Serial No. which is located either on the rear, bottom or side of the cabinet. Retain this information for future reference.

Model No.: _____

Serial No.: _____

Purchase date: _____

Name of dealer: _____

JVC

JVC COMPANY OF AMERICA
DIVISION OF US JVC CORP.
41 Slater Drive, Elmwood Park, N.J. 07407

JVC CANADA INC.
21 Finchdene Square, Scarborough Ontario M1X 1A7